

**TEREX**  **CRANES**



*CUSTOM SERVICE CRANE, INC.*

# T 230



# **T 230** *Notable Features*

- **Boom – 30-94' ft (9.23-28.49m)**
- **Jib – 26 ft (7.92m) or 26-43' (7.92-13.11m) (off settable)**
- **Engine – Cummins 6CTAA8.3 250 horsepower with Fuller 10 Speed manual transmission**
- **Winch -**
  - **fpm: 474**
  - **Max Line Pull : 13,000 lbs**
- **Pumps – Gear Pumps (3) / Total GPM: 115**
- **Tires -**
  - **Front: 425/65R 22.5 18 PR**
  - **Rear: 10.00 x 20-14 PR**



# TEREX T 200 SERIES Truck Crane



## FEATURES

- **20-30 tons (18-27 mt)**  
maximum lifting capacity
- **94 ft. (28.6 m)**  
maximum boom length
- **141 ft. (43.0 m)**  
maximum tip height
- Four-section full power, mechanically synchronized boom with single lever control
- Swingaway jib offsettable 0°, 15° or 30°
- Two-speed main and auxiliary winches
- Quick-reeving boom head and hook block
- Fully independent multi-position out and down outriggers
- Environmental operator's cab optimizes load visibility and productivity
- RCI 500 load system Rated Capacity Indicator
- Travel speeds to 60 mph (96 km/h)
- Easy to read load chart books include range diagrams
- 12-month or 2000 hours warranty, major weldments are 5-years or 10,000 hours

simple, available and  
cost effective™

Machines shown may have optional equipment.

# TEREX T 200 SERIES

## Truck Cranes

- T 220 – 20 tons (18 mt)
- T 225 – 25 tons (22 mt)
- T 228 – 28 tons (25 mt)
- T 230 – 30 tons (27 mt)

## 94 ft. (28.6 m) FOUR-SECTION, FULL-POWER BOOM WITH SINGLE LEVER CONTROL

- High strength, four plate construction welded inside and out with embossed side plate holes to reduce weight and increase strength.
- Single boom hoist cylinder provides boom elevation of -4° to 76° for easier reeving changes and close radius operation.
- Quick-reeving boom head; no need to remove wedge from socket.
- 360° house lock standard.

## ENVIRONMENTAL OPERATOR'S CAB

- Rated Capacity Indicator (RCI) system including anti-two block system with automatic function disconnects.
- Deluxe six-way operator's seat has torsion bar suspension and adjustable head and arm rests.
- Sound and weather insulated for comfort.
- Removable front window, hinged tinted glass skylight, and sliding right-hand window.
- Hand operated control levers for swing, boom telescope, boom hoist, and single lever two-speed main winch; foot control pedals for swing brake and boom raise, boom lower, and throttle.
- Complete instrumentation. Environmentally-sealed rocker switches. Circuit breakers in cab.

## RUGGED, EASY-TO-MANEUVER CARRIER

- Chassis is Terex designed and built with 6 x 4 drive.
- Full aluminum decking improves access and reduces weight.
- Manual transmission with 10 speeds forward, 3 reverse, and neutral safety start standard.
- Full air brakes on all wheels with split circuit system.
- Fully independent hydraulic outriggers may be utilized fully extended to 20 ft. (6.10 m), in their 1/2 extended position, or fully retracted.
- Standard Cummins ISC-285 diesel engine.
- Tachometer and aluminum rims standard

## POWERFUL, TWO-SPEED WINCHES

- 484 fpm (147 mpm) maximum line speed, 12,510 lbs. (5673 kg) maximum line pull. Single lever control.
- Integral automatic brake.
- Electronic drum indicators.
- Winch drum rollers, tapered drum flanges.

## HIGH CAPACITY, DEPENDABLE HYDRAULIC SYSTEM

- Three gear pumps driven from engine flywheel housing PTO. Combined system capability is 115 gpm (435 lpm)



- Hydraulic reservoir with 91 gal. (344 l) capacity and full flow oil filtration system.

## OPTIONS INCLUDE:

- 26 ft. or 26 to 43 ft. (7.92 or 7.92 to 13.11 m) swingaway jib. Both offset 0°, 15° or 30°.
- Auxiliary winch with rope.
- Heater/defroster, air conditioner for operator's cab.
- Air conditioner for carrier cab.
- Heavy counterweight package.
- Cold weather kit for carrier cab.
- 6 speed automatic transmission with Cummins ISC-285 diesel engine.
- Front and/or rear air suspension.

For more information, product demonstration, or details on purchase, lease and rental plans, please contact your local Terex Cranes Distributor.



**CUSTOM SERVICE CRANE, INC.**

217-897-1700

[www.CustomServiceCrane.com](http://www.CustomServiceCrane.com)

[Randy@customservicecrane.com](mailto:Randy@customservicecrane.com)

We reserve the right to amend these specifications at any time without notice. The only warranty applicable is our standard written warranty applicable to the particular product and sale. We make no other warranty, expressed or implied.



**TEREX CRANES**

106 12th Street S.E.  
Waverly, IA 50677-9466 USA  
(319) 352-3920 • FAX: (319) 352-5727  
E-mail: [waverly@terexlifting.com](mailto:waverly@terexlifting.com)

[www.terexlift.com](http://www.terexlift.com)



# TEREX T 200 SERIES

truck cranes  
specifications

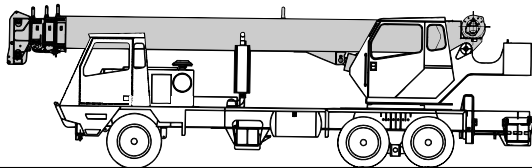

---

## STANDARD BOOM EQUIPMENT

### BOOM

30-94 ft. (9.23-28.49 m), four section full power, mechanically synchronized boom. High-strength four plate construction with embossed side plate holes to reduce weight and increase strength. Anti-friction slide pads. A single boom hoist cylinder provides for boom elevation of -4 to 76 degrees. Maximum tip height is 99 ft. (30.17 m).

### BOOM HEAD

Welded to outer section of boom. Four or five load sheaves and two idler sheaves mounted on heavy duty, anti-friction bearings. Quick reeving boom head. Provisions made for side-stow jib mounting.

---

## OPTIONAL BOOM EQUIPMENT

### MAIN BOOM

30-72 ft. (9.23-22.19 m), three section full power, mechanically synchronized boom. High-strength four plate construction with embossed side plate holes to reduce weight and increase strength. Anti-friction slide pads. A single boom hoist cylinder provides for boom elevation of -4 to 76 degrees. Maximum tip height is 79 ft. (24.23 m).

### JIBS

26 ft. (7.92 m) side stow swing-on one-piece lattice type jib. Single sheave mounted on anti-friction bearing. Jib is offsettable at 0°, 15°, or 30°. Maximum tip height is 124 ft (37.77 m) with 94 ft. (28.49 m) boom.

26-43 ft. (7.92-13.11 m) side stow swing-on lattice type jib. Single sheave mounted on anti-friction bearing. Jib is extendible to 43 ft. (13.11 m) by means of a 17 ft. (5.18 m) manual pull-out tip section, roller supported for

ease of extension. Jib is offsettable at 0°, 15°, or 30°. Maximum tip height is 141 ft. (42.99 m) with 94 ft. (28.49 m) boom.

### AUXILIARY BOOM HEAD

Removable auxiliary boom head has single sheave mounted on anti-friction bearing. Removable pin-type rope guard for quick reeving. Installs on main boom peak only. Removal is not required for jib use.

### HOOK BLOCK

Two, three or four metallic sheaves on anti-friction bearings with hook and heavy duty hook latch. Quick reeving design does not require removal of wedge and socket from rope.

### HOOK & BALL

7 ton (6.3 mt) top swivel ball with hook and hook latch.

---

## STANDARD UPPERSTRUCTURE EQUIPMENT

### UPPERSTRUCTURE FRAME

All welded one-piece structure fabricated with high tensile strength alloy steel. Counterweight is bolted to frame.

### TURNTABLE CONNECTION

Swing bearing is a single row, ball type, with external teeth. The swing bearing is bolted to the revolving upperstructure and welded to the carrier frame.

### SWING

A hydraulic motor drives a double planetary reduction gear for precise and smooth swing function. Swing speed (no load) is 3.0 rpm.

### SWING BRAKE

Heavy duty multiple disc swing brake is mechanically actuated from operator's cab by foot pedal. Brake may be locked on or used as a momentary brake.

### RATED CAPACITY INDICATOR

Rated Capacity Indicator with visual and audible warning system and automatic function disconnects. Pictographic display includes: boom radius, boom angle, boom length, allowable load, actual load, and percentage of allowable load registered by bar graph. Operator settable alarms provided for swing angle, boom length, boom angle, tip height, and work area exclusion zone. Anti-two block system includes audio/visual warning and automatic function disconnects.

### OPERATOR'S CAB

Environmental cab with all steel construction, optimized visibility, tinted safety glass throughout, and rubber floor matting is mounted on vibration absorbing pads. The cab has a sliding door on the left side, framed sliding window on the right side, hinged tinted all glass skylight and removable front windshield to provide optimized visibility of the load open or closed. Acoustical foam padding insulates against sound and weather. The deluxe six-way adjustable operator's seat is equipped with a torsion bar suspension and includes head and arm rests.

---

## STANDARD CARRIER EQUIPMENT

### CARRIER CHASSIS

High strength chassis with 6 x 4 drive. Triple box construction frame is fabricated from high strength alloy steel and provides superior frame rigidity. Full aluminum decking reduces weight. Aluminum engine housing with sliding cover optimizes engine access while reducing weight and improving corrosion resistance.

### AXLES AND SUSPENSION

Rear Axles - 40,000 lb. (18,144 kg) capacity tandem axles with heat treated housings have interaxle differential with lockout. Axles are mounted on equalizer beams to distribute weight evenly. Front Axle - I beam type axle is heavy duty multi-leaf spring-mounted with shock absorbers.

### TIRES

Front: Two 425/65R22.5-18 P.R. All-position type tubeless.  
Rear: Eight 10.00 x 20-14 P.R. transport type.

### BRAKES

Full air brakes on all wheels with split circuit system.

Front brakes: 16.5 x 6 in. (419 x 152 mm)

Rear brakes: 16.5 x 7 in. (419 x 178 mm)

All brakes are extended service air operated "S" cam type with automatic slack adjusters.

Lining areas are 384 in<sup>2</sup> (2477 cm<sup>2</sup>) front and 920 in<sup>2</sup> (5935 cm<sup>2</sup>) rear. Air compressor has standard air dryer. Rear tandem axles have spring-set, air-released parking/emergency brake chambers. Parking brake is applied with valve mounted on dash

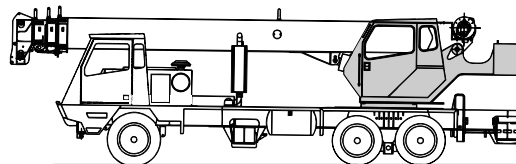

### CONTROLS

All control levers and pedals are positioned for efficient operation. Hand operated control levers include swing, boom telescope, boom hoist, winch(s), vernier adjustable hand throttle, and two position house lock. Switches include ignition, engine stop, lights, horn, windshield wipers, defroster, outriggers, etc. Horn switch is mounted in the swing lever. Foot control pedals include swing brake, boom raise, boom lower, and throttle.

### INSTRUMENTATION AND ACCESSORIES

In-cab gauges include bubble level, engine oil pressure, fuel, engine temperature, voltmeter. Indicators include high coolant temperature/low engine oil pressure audio/visual warning, low coolant level audio/visual warning, hoist drum rotation indicator and Rated Capacity Indicator. Accessories include fire extinguisher, windshield washer/wiper, skylight wiper, L.H. rear view mirror, dash and dome lights, and seat belt. Circuit breakers protect electrical circuits.

### HYDRAULIC CONTROL VALVES

Valves are mounted on the rear of the upperstructure and are easily accessible. Valves are mechanically operated and include one four spool valve for boom elevation, telescope, main winch boost, and main winch; one single spool valve for swing; and one single spool valve for future installation of an auxiliary winch. High pressure regeneration feature provides 2-speed boom extension. Quick disconnects are provided for ease of installation of pressure check gauges.

---

### OPTIONAL EQUIPMENT

Auxiliary Winch • 360° House Lock • LP Heater/Defroster • Hydraulically Powered Air Conditioner • Diesel Heater/Defroster • Tachometer • Work Lights • Outrigger Controls on Sides of Carrier • Heavy Counterweight Package

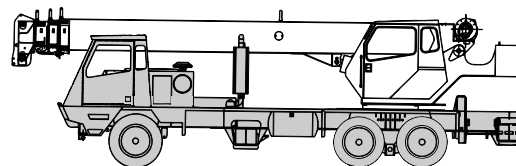

panel. Emergency brakes apply automatically when air pressure drops below 60 psi (4.2 kg/cm<sup>2</sup>).

### STEERING

Mechanism includes rack and pinion with integral hydraulic power.

	To $\phi$ of tires	To corner of carrier
Turning radius:	34'-0" (10.35m)	37'-7" (11.46 m)

### TRANSMISSION

Standard: Fuller RT 8908LL transmission has 10 speeds forward and 3 reverse, with neutral safety start. Gear selection is accomplished by single lever shift control and two position air shift range selector.

Optional: Allison MD3560 provides 6 speeds forward with lock-up in top 5 gears. Adaptive feed back controls continually optimize shifts for weight, terrain, etc.

### MULTI-POSITION OUT & DOWN OUTRIGGERS

Fully independent hydraulic outriggers may be utilized fully extended, in their 1/2 extended position, or fully retracted. Removable aluminum outrigger pads are 452 in<sup>2</sup> (2919 cm<sup>2</sup>) and stow on the carrier frame. Complete controls and sight leveling bubble are located in the operator's cab. Includes 5th, front outrigger.

# STANDARD CARRIER EQUIPMENT (continued)

## CARRIER CAB

One-man aluminum cab is mounted on vibration absorbing pads and has optimized visibility, safety glass, acoustical foam padding inside cab for insulating against sound and weather, six-way adjustable torsion bar suspension seat with seat belt and lockable door with roll down window.

## CONTROLS

Included are transmission shift, inter-axle differential lock, parking brake, two-speed windshield wiper/washer, heater and defroster, lights, headlight dimmer, dome light, and ignition switch.

## INSTRUMENTS

Included are speedometer, hour meter, tachometer, voltmeter, fuel gauge, engine oil pressure gauge, water temperature gauge, dual air pressure gauges. Warning lights include low coolant level, parking brakes on, low air, pumps engaged, and high beam lights.

## ACCESSORIES

Included are fire extinguisher, right hand and left hand rear view mirrors, electric horn, access steps and grab handles (located at four separate locations around the crane), back-up alarm, two position boom rack, front and rear towing loops. Circuit breakers protect electrical circuits.

## LIGHTS

Light package includes headlights with foot operated dimmer switch, clearance lights, trail lights, directional signal lights, four-way hazard flasher lights, back-up lights with audible alarm.

## OPTIONAL EQUIPMENT

Spare Tire with Wheel • Immersion Heater(s) • Pintle Hook • Cold Weather Kit • Allison MD3560 6 speed Automatic Transmission with 275 HP Cummins 6CTA8.3 CAC Diesel Engine • Air Suspension for Drivers Seat

# HYDRAULIC SYSTEM

## HYDRAULIC PUMPS

Triple pump driven from engine flywheel housing PTO with air shifted mechanical pump disconnect at 1.15 times engine speed. A separate steering pump is driven directly from the engine. Combined system capacity is 115 gpm (435 lpm). Hydraulic oil cooler is standard.

### Main Winch Pump

54 gpm (204.4 lpm) @ 3,500 psi (246.1 kg/cm<sup>2</sup>)

### Boom Hoist and Telescope Pump

39 gpm (147.6 lpm) @ 3,500 psi (246.1 kg/cm<sup>2</sup>)

### Outrigger and Swing Pump

22 gpm (83.3 lpm) @ 2,500 psi (175 kg/cm<sup>2</sup>)

## Power Steering Pump

8 gpm (30.3 lpm) @ 1500 psi (105.5 kg/cm<sup>2</sup>)

## FILTRATION

Full flow oil filtration system with bypass protection includes a removable 60 mesh (250 micron) suction screen-type filter and 5 micron replaceable return line filter.

## HYDRAULIC RESERVOIR

All welded construction with internal baffles and diffuser. Provides easy access to filters and is equipped with an external sight level gauge. The hydraulic tank is pressurized to aid in keeping out contaminants and in reducing potential pump cavitation. Capacity is 91 gal (344 liters).

# MAIN WINCH SPECIFICATIONS

Hydraulic winch with geroller® motor and planetary reduction gearing provides 2-speed operation with equal speeds for power up and down. Winch is equipped with an integral automatic brake, grooved drum, tapered flanges, standard cable roller on drum, and electronic drum rotation indicator.

PERFORMANCE	LO-RANGE	HI-RANGE
Max. line speed (no load)		
First layer	190 fpm (57.9 m/min)	328 fpm (100 m/min)
Fifth layer	275 fpm (83.8 m/min)	474 fpm (144.5 m/min)
Max. line pull-first layer	13,000 lbs. (5897 kg)	10,300 lbs. (4672 kg)
Max. line pull-fifth layer	9,022 lbs. (4092 kg)	7150 lbs. (3243 kg)
Permissible line pull	9,040 lbs (4100 kg)	

DRUM DIMENSIONS	DRUM CAPACITY
10.62 in (270 mm) drum diameter	Max. Storage: 560 ft (170.7 m)
16.00 in (406 mm) length	6th layer not a working layer
17.88 in (454 mm) flange dia.	Max. Usable: 447 ft. (136.2 m)*
Cable: 5/8" x 450 ft. (16 mm x 137.2 m)	*Based on minimum flange height above
Cable type: 5/8" (16 mm) 6x19 IWRC IPS	top layer to comply with ANSI B30.5
right regular lay, preformed. Min. breaking strength 17.9 tons (16.2 mt).	

# OPTIONAL AUX. WINCH

Hydraulic 2-speed winch with geroller® motor, equal speed power up and down, planetary reduction with integral automatic brake, grooved drum with tapered flanges, drum roller, and rotation indicator.

## PERFORMANCE

Max. line speed (no load)	
Fifth layer	275 fpm (83.8 m/min)
Max. line pull	
First layer	13,000 lbs. (5897 kg)

## DRUM DIMENSIONS AND CAPACITY

(Same as main winch)

## OPTIONAL HOIST LINE

MAIN WINCH AND OPTIONAL AUXILIARY WINCH – 5/8" (16 mm) rotation resistant compacted strand 18 x 19 or 19 x 19. Min. breaking strength 22.6 tons (20.6 mt).

# ENGINE SPECIFICATIONS

Make and Model	Cummins 6CTAA-8.3L(250 hp)
Type	6 cylinder
Bore and Stroke	4.49 x 5.32 in. (114 x 135 mm)
Displacement	504.5 cu. in. (8.27 l)
Max. Gross Horsepower	250 hp (186 kw) @ 2200 rpm
Max. Gross Torque	800 lbs•ft. (111 kg•m)/1300 rpm
Net Horsepower	222 hp (165 kw) @ 2200 rpm
Aspiration	turbocharged
Electrical System	12 volt
Alternator	100 amp
Battery	(2) 12V-1600 C.C.A. @ 0°F (-18°C)
Fuel Capacity	60 gal (227 l)

# SPEED AND GRADEABILITY

ENGINE TRANSMISSION	SPEED RANGE	GRADEABILITY
Cummins Manual	60 mph (96 km/h)	56%
Cummins Automatic	60 mph (96 km/h)	64%

# GENERAL DIMENSIONS

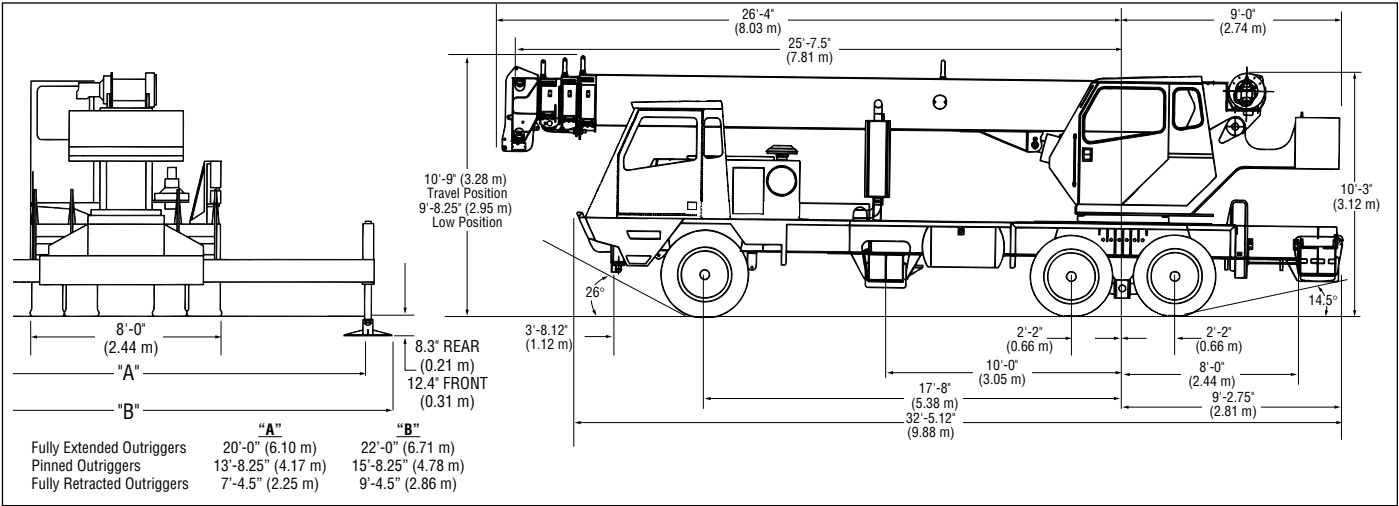

WEIGHTS & AXLE LOADS	GROSS WEIGHT LBS.	UPPER IN TRAVEL POSITION		GROSS WEIGHT KG.	UPPER IN TRAVEL POSITION	
		FRONT	REAR		FRONT	REAR
<b>Basic Crane with 6CTAA-8.3L, Engine, 94' (28.49 m) Boom, 2,000 + 500 lb. (907 + 227 kg) Cwt., 1/4 Tank of fuel, 425/65Rx22.5 18 PR Front and 10.00x20 14 PR Rear Tires with Disc Wheels, and 200 lb. Operator in cab.</b>	<b>46,513</b>	<b>15,382</b>	<b>31,131</b>	<b>21,098</b>	<b>6,977</b>	<b>14,121</b>
Add Options:						
26" (7.92 m) Swing-on Jib	+ 1,040	+ 808	+ 232	+ 472	+ 366	+ 106
26'-43" (7.92 - 13.11 m) Swing-on Jib	+ 1,491	+ 1,077	+ 414	+ 676	+ 489	+ 187
Auxiliary Boom Head	+ 100	+ 180	- 80	+ 45	+ 82	- 37
Full Tank of Fuel	+ 315	+ 120	+ 195	+ 142	+ 54	+ 88
Auxiliary Winch W/Drum Roller and Wire Rope (Hwy Cwt)	+ 19	- 1	+ 18	+ 8	+ 0	+ 8
Heater/Defroster (Upper)	+ 60	- 5	+ 65	+ 27	- 2	+ 25
Work Lights	+ 35	+ 5	+ 30	+ 16	+ 2	+ 18
Pintle Hook (Rear)	+ 50	- 26	+ 76	+ 23	- 12	+ 34
Electric Remote Control	+ 200	+ 100	+ 100	+ 91	+ 45	+ 45
30 ton (27.2 mt) Quick Reeving Hook Block (On Bumper - 4 Sheave)	+ 655	+ 924	- 269	+ 297	+ 441	- 128
30 ton (27.2 mt) Quick Reeving Hook Block (On Bumper - 3 Sheave)	+ 670	+ 945	- 275	+ 304	+ 429	- 125
25 ton (22.7 mt) Quick Reeving Hook Block (On Bumper - 2 Sheave)	+ 682	+ 962	- 280	+ 309	+ 436	- 127
7 ton (6.3 mt) Hook and Ball (At boom rack)	+ 240	+ 145	+ 95	+ 109	+ 66	+ 43
<b>Substitute:</b>	- 1,954	- 2,122	+ 168	- 886	- 962	+ 76
30-72' (9.23-22.19 m) Boom W/3, 100 lb. (1406 kg) Upper Cwt & 500 lb. (227 kg) F. Bumper						
7,200 lb. (3266 kg) Upper Cwt.w/1,850 lb. (839 kg) Bumper (94' Boom)	+ 6,636	- 619	+ 7,255	+ 3010	- 281	+ 3291
7,200 lb. (3266 kg) Upper Cwt.w/1,850 lb. (839 kg) F. Bumper (72' Boom)	+ 5,445	+ 758	+ 4,687	+ 2470	+ 344	+ 2126
Aux. Winch w/Drum Roller For Heavy Cwt (above)	+ 5	+ 5	+ 0	+ 2	+ 2	0
Add for Spin Resistant Wire Rope (per winch)	+ 19	- 1	+ 18	+ 8	0	+ 8
360° Mechanical House Lock	+ 85	0	+ 85	+ 39	0	+ 39
Aluminum Disc Wheels (Std Tires)	- 366	- 134	- 232	- 166	- 61	- 105
Automatic Transmission	0	0	0	0	0	0
Automatic Transmission w/2-spd Aux & 2 -spd Axles	+ 510	+ 300	+ 210	+ 231	+ 136	+ 95

**NOTE:** Weights are for factory supplied equipment and subject to 2% variation due to manufacturing tolerances.

WE RESERVE THE RIGHT TO AMEND THESE SPECIFICATIONS AT ANY TIME WITHOUT NOTICE. THE ONLY WARRANTY APPLICABLE IS OUR STANDARD WRITTEN WARRANTY APPLICABLE TO THE PARTICULAR PRODUCT AND SALE. WE MAKE NO OTHER WARRANTY, EXPRESSED OR IMPLIED.



106 12th Street S.E.  
 Waverly, IA 50677-9466 USA  
 (319) 352-3920 • FAX: (319) 352-5727  
 E-mail: inquire@terexwaverly.com







# TEREX T 230

truck crane  
30 ton capacity

## range diagram & lifting capacities

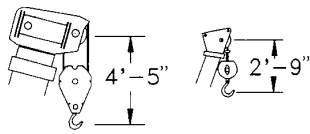

DIMENSIONS ARE FOR LARGEST FACTORY FURNISHED HOOK BLOCK AND HOOK & BALL, WITH ANTI-TWO BLOCK ACTIVATED

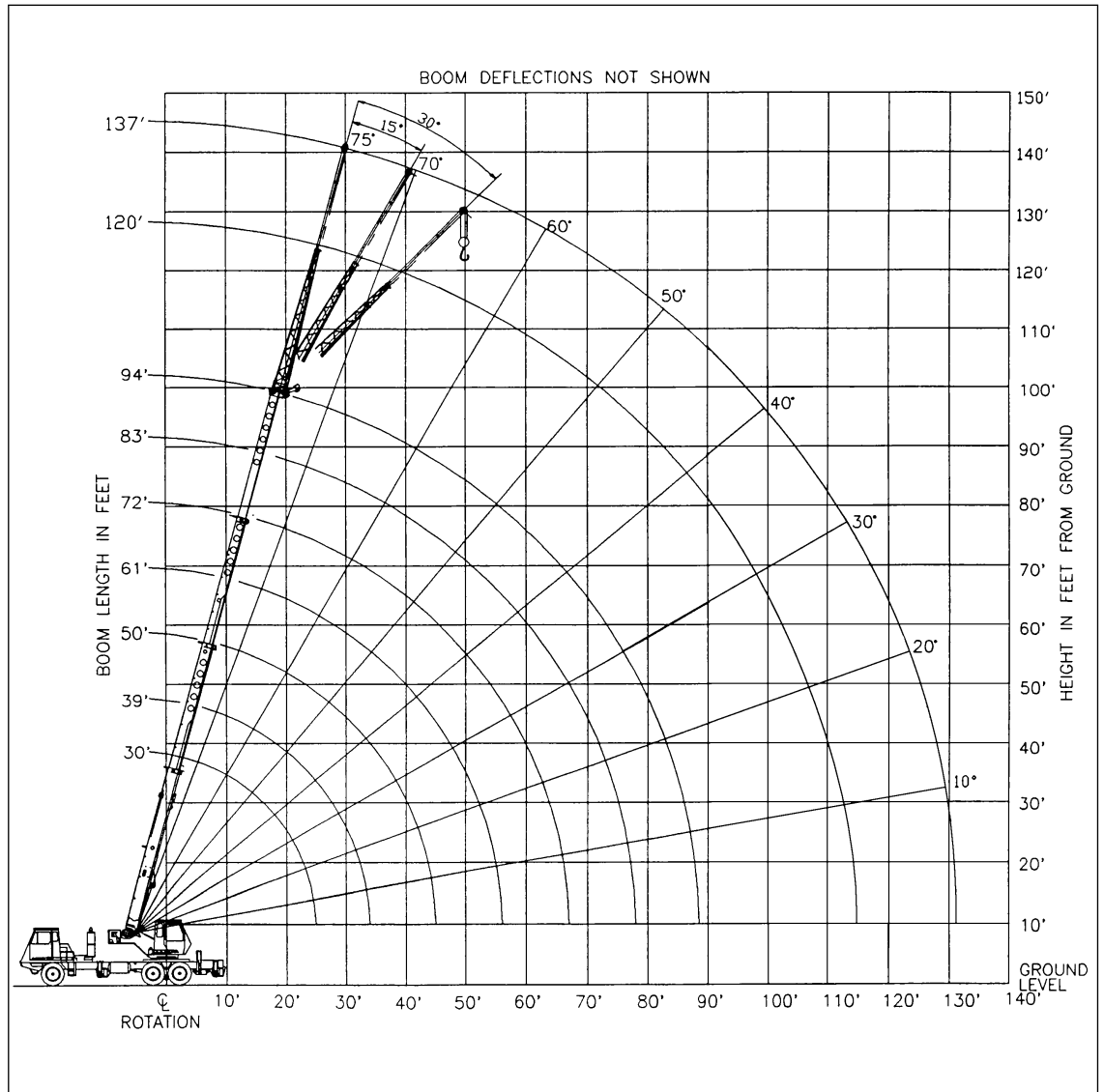

Range Diagram  
(30' - 94' boom)

### CRANE WORKING CONDITIONS

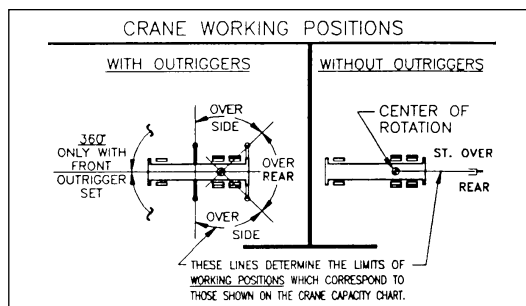

### REDUCTION IN MAIN BOOM CAPACITY

All Jibs in Stowed Position \_\_\_\_\_ 0 Lbs.  
Aux. Boom in Head Sheave \_\_\_\_\_ 100 Lbs.

### HOOK BLOCK WEIGHTS

Hook & Ball \_\_\_\_\_ 239 Lbs.  
25T Hook Block (2 Sheave) \_\_\_\_\_ 682 Lbs.  
30T Hook Block (3 Sheave) \_\_\_\_\_ 670 Lbs.  
40T Hook Block (4 Sheave) \_\_\_\_\_ 690 Lbs.

# Lifting Capacities – Pounds (30’ – 94’ boom)

## MODEL T 230

COUNTERWEIGHT:  
F. BUMPER 500 LBS.  
UPPERSTRUCTURE:  
W/AUX. WINCH 900 LBS.  
W/O AUX. WINCH 2000 LBS.

BOOM LENGTH 30-94 FT.  
STABILITY PCT.  
ON OUTRIGGERS 85%  
ON TIRES 75%  
PCSA CLASS 10-89

**CAUTION:** Do not use this specification sheet as a load rating chart. The format of data is not consistent with the machine chart and may be subject to change.

### ON OUTRIGGERS - FULLY EXTENDED

LOAD RADIUS (FT)	BOOM LENGTH 30 FT			BOOM LENGTH 39 FT			BOOM LENGTH 50 FT			LOAD RADIUS (FT)
	LOADED BOOM ANGLE (DEG)	OVER REAR (LB)	360° (LB)	LOADED BOOM ANGLE (DEG)	OVER REAR (LB)	360° (LB)	LOADED BOOM ANGLE (DEG)	OVER REAR (LB)	360° (LB)	
10	62.5	60,000*	60,000*	69.1	46,600*	46,600*				10
12	58.1	49,600*	49,600*	65.9	39,100*	39,100*	71.4	44,500*	44,500*	12
15	51.0	38,400*	38,400*	60.9	40,000*	40,000*	67.7	38,500*	38,500*	15
20	37.0	27,000*	27,000*	51.9	27,800*	27,800*	61.4	28,300*	28,300*	20
25	13.2	20,000*	20,000*	41.7	20,900*	20,900*	54.5	21,500*	21,500*	25
30	**			28.5	16,300*	15,300	47.0	16,900*	15,900	30
35				**			38.4	13,600*	11,700	35
40							27.6	11,100	8,900	40
45							7.6	8,800	6,700	45
50							**			50
55										55
60										60
65										65
70										70
75										75
80										80
85										85

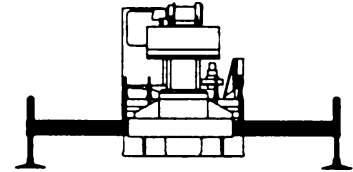

**USE THESE CHARTS ONLY  
WHEN ALL OUTRIGGERS  
ARE FULLY EXTENDED**

### ON OUTRIGGERS - FULLY EXTENDED

LOAD RADIUS (FT)	BOOM LENGTH 61 FT			BOOM LENGTH 72 FT			BOOM LENGTH 83 FT			BOOM LENGTH 94 FT			LOAD RADIUS (FT)
	LOADED BOOM ANGLE (DEG)	OVER REAR (LB)	360° (LB)	LOADED BOOM ANGLE (DEG)	OVER REAR (LB)	360° (LB)	LOADED BOOM ANGLE (DEG)	OVER REAR (LB)	360° (LB)	LOADED BOOM ANGLE (DEG)	OVER REAR (LB)	360° (LB)	
10													10
12													12
15	71.9	36,000*	36,000*										15
20	66.9	28,700*	28,700*	70.6	27,400*	27,400*							20
25	61.6	21,800*	21,800*	66.3	22,100*	22,100*	69.6	19,000*	19,000*	72.1	15,300*	15,300*	25
30	56.1	17,300*	16,200	61.8	17,500*	16,400	65.9	15,900*	15,900*	68.8	13,100*	13,100*	30
35	50.2	14,000*	12,000	57.2	14,200*	12,200	62.0	13,800*	12,300	65.5	11,400*	11,400*	35
40	43.7	11,500	9,200	52.3	11,700	9,400	58.0	11,800	9,500	62.1	10,000*	9,600	40
45	36.2	9,200	7,200	47.0	9,500	7,400	53.8	9,600	7,500	58.6	8,800*	7,600	45
50	27.1	7,500	5,700	41.2	7,800	5,900	49.4	7,900	6,000	54.9	7,900*	6,100	50
55	12.8	6,100	4,400	34.7	6,400	4,700	44.6	6,600	4,800	51.1	6,700	4,900	55
60	**			26.7	5,300	3,700	39.4	5,500	3,900	47.0	5,600	4,000	60
65				15.3	4,400	2,900	33.5	4,600	3,100	42.7	4,700	3,200	65
70				**			26.4	3,800	2,400	37.9	3,900	2,600	70
75							16.8	3,100	1,900	32.5	3,300	2,000	75
80							**			26.2	2,700	1,500	80
85										18.0	2,200	1,100	85

### \*\* MAXIMUM CAPACITY AT 0 DEGREE BOOM ANGLE

BOOM LENGTH 30 FT			BOOM LENGTH 39 FT			BOOM LENGTH 50 FT			BOOM LENGTH 61 FT			BOOM LENGTH 72 FT			BOOM LENGTH 83 FT			BOOM LENGTH 94 FT		
LOAD RADIUS (FT)	OVER REAR (LB)	360° (LB)	LOAD RADIUS (FT)	OVER REAR (LB)	360° (LB)	LOAD RADIUS (FT)	OVER REAR (LB)	360° (LB)	LOAD RADIUS (FT)	OVER REAR (LB)	360° (LB)	LOAD RADIUS (FT)	OVER REAR (LB)	360° (LB)	LOAD RADIUS (FT)	OVER REAR (LB)	360° (LB)	LOAD RADIUS (FT)	OVER REAR (LB)	360° (LB)
25.6	19,200*	19,200*	34.3	13,200*	11,300	45.3	8,600	6,600	56.3	5,700	4,100	67.3	3,900	2,500	78.3	2,700	1,500	89.3	1,800	700

# Lifting Capacities – Pounds (30’ – 94’ boom)

## MODEL T 230

COUNTERWEIGHT: BOOM LENGTH 30-94 FT.  
 F. BUMPER 500 LBS. STABILITY PCT.  
 UPPERSTRUCTURE: ON OUTRIGGERS 85%  
 W/AUX. WINCH 900 LBS. ON TIRES 75%  
 W/O AUX. WINCH 2000 LBS. PCSA CLASS 10-89

**CAUTION:** Do not use this specification sheet as a load rating chart. The format of data is not consistent with the machine chart and may be subject to change.

### ON OUTRIGGERS - MID POSITION

LOAD RADIUS (FT)	BOOM LENGTH 30 FT		BOOM LENGTH 39 FT		BOOM LENGTH 50 FT		BOOM LENGTH 61 FT		BOOM LENGTH 72 FT		BOOM LENGTH 83 FT		BOOM LENGTH 94 FT	
	LOADED BOOM ANGLE (DEG)	360° (LB)	LOADED BOOM ANGLE (DEG)	360° (LB)	LOADED BOOM ANGLE (DEG)	360° (LB)	LOADED BOOM ANGLE (DEG)	360° (LB)	LOADED BOOM ANGLE (DEG)	360° (LB)	LOADED BOOM ANGLE (DEG)	360° (LB)	LOADED BOOM ANGLE (DEG)	360° (LB)
10	62.5	60,000*	69.1	46,600*										
12	58.1	49,600*	65.9	46,600*	71.4	44,500*								
15	51.0	30,000	60.9	30,800	67.7	31,400	71.9	31,700						
20	37.0	16,100	51.9	17,000	61.4	17,500	66.9	17,800	70.6	18,000				
25	13.2	9,700	41.7	10,700	54.5	11,300	61.6	11,600	66.3	11,700	69.6	11,900	72.1	12,000
30	**		28.5	7,100	47.0	7,700	56.1	8,000	61.8	8,200	65.9	8,300	68.8	8,400
35			**		38.4	5,300	50.2	5,700	57.2	5,900	62.0	6,000	65.5	6,100
40					27.6	3,700	43.7	4,000	52.3	4,300	58.0	4,400	62.1	4,500
45					7.6	2,400	36.2	2,800	47.0	3,100	53.8	3,200	58.6	3,300
50					**		27.1	1,800	41.2	2,100	49.4	2,300	54.9	2,400
55							12.8	1,100	34.7	1,300	44.6	1,500	51.1	1,600
60							**		26.7	700	39.4	900	47.0	1,000

### \*\* MAXIMUM CAPACITY AT 0 DEGREE BOOM ANGLE

BOOM LENGTH 30 FT		BOOM LENGTH 39 FT		BOOM LENGTH 50 FT		BOOM LENGTH 61 FT		BOOM LENGTH 72 FT		BOOM LENGTH 83 FT		BOOM LENGTH 94 FT	
LOAD RADIUS (FT)	360° (LB)	LOAD RADIUS (FT)	360° (LB)	LOAD RADIUS (FT)	360° (LB)	LOAD RADIUS (FT)	360° (LB)	LOAD RADIUS (FT)	360° (LB)	LOAD RADIUS (FT)	360° (LB)	LOAD RADIUS (FT)	360° (LB)
25.6	9,000	34.3	4,800	45.3	2,200	56.3	800						

### ON OUTRIGGERS - RETRACTED

LOAD RADIUS (FT)	BOOM LENGTH 30 FT		BOOM LENGTH 39 FT		BOOM LENGTH 50 FT		BOOM LENGTH 61 FT		BOOM LENGTH 72 FT		BOOM LENGTH 83 FT		BOOM LENGTH 94 FT		LOAD RADIUS (FT)
	LOADED BOOM ANGLE (DEG)	360° (LB)	LOADED BOOM ANGLE (DEG)	360° (LB)	LOADED BOOM ANGLE (DEG)	360° (LB)	LOADED BOOM ANGLE (DEG)	360° (LB)	LOADED BOOM ANGLE (DEG)	360° (LB)	LOADED BOOM ANGLE (DEG)	360° (LB)	LOADED BOOM ANGLE (DEG)	360° (LB)	
10	62.5	21,900	69.1	22,700											10
12	58.1	15,300	65.9	16,000	71.4	16,500									12
15	51.0	9,600	60.9	10,400	67.7	10,900	71.9	11,100							15
20	37.0	4,700	51.9	5,500	61.4	6,100	66.9	6,300	70.6	6,500					20
25	13.2	2,000	41.7	2,900	54.5	3,400	61.6	3,800	66.3	3,900	69.6	4,000	72.1	4,100	25
30	**		28.5	1,200	47.0	1,800	56.1	2,100	61.8	2,300	65.9	2,400	68.8	2,500	30
35			**		38.4	600	50.2	1,000	57.2	1,200	62.0	1,300	65.5	1,400	35

### \*\* MAXIMUM CAPACITY AT 0 DEGREE BOOM ANGLE

BOOM LENGTH 30 FT		BOOM LENGTH 39 FT		BOOM LENGTH 50 FT		BOOM LENGTH 61 FT		BOOM LENGTH 72 FT		BOOM LENGTH 83 FT		BOOM LENGTH 94 FT	
LOAD RADIUS (FT)	360° (LB)	LOAD RADIUS (FT)	360° (LB)	LOAD RADIUS (FT)	360° (LB)	LOAD RADIUS (FT)	360° (LB)	LOAD RADIUS (FT)	360° (LB)	LOAD RADIUS (FT)	360° (LB)	LOAD RADIUS (FT)	360° (LB)
25.6	1,600												

# Lifting Capacities – Pounds (30' – 94' boom)

## MODEL T 230

COUNTERWEIGHT:  
F. BUMPER 500 LBS.  
UPPERSTRUCTURE:  
W/AUX. WINCH 900 LBS.  
W/O AUX. WINCH 2000 LBS.

BOOM LENGTH 30-94 FT.  
STABILITY PCT.  
ON OUTRIGGERS 85%  
ON TIRES 75%  
PCSA CLASS 10-89

**CAUTION:** Do not use this specification sheet as a load rating chart. The format of data is not consistent with the machine chart and may be subject to change.

### SIDE STOW JIB ON FULLY EXTENDED OUTRIGGERS

LOADED BOOM ANGLE (DEG)	26 FT OFFSETABLE JIB									43 FT OFFSETABLE JIB									LOADED BOOM ANGLE (DEG)
	0° OFFSET			15° OFFSET			30° OFFSET			0° OFFSET			15° OFFSET			30° OFFSET			
	LOAD RADIUS (REF) (FT)	REAR ONLY (LB)	360° (LB)	LOAD RADIUS (REF) (FT)	REAR ONLY (LB)	360° (LB)	LOAD RADIUS (REF) (FT)	REAR ONLY (LB)	360° (LB)	LOAD RADIUS (REF) (FT)	REAR ONLY (LB)	360° (LB)	LOAD RADIUS (REF) (FT)	REAR ONLY (LB)	360° (LB)	LOAD RADIUS (REF) (FT)	REAR ONLY (LB)	360° (LB)	
75	35	9,100*	9,100*	40	7,400*	7,400*	45	5,600*	5,600*	41	5,100*	5,100*	50	3,400*	3,400*	62	2,700*	2,700*	75
73	39	8,600*	8,600*	43	6,800*	6,800*	49	5,300*	5,300*	45	4,800*	4,800*	54	3,300*	3,300*	65	2,700*	2,700*	73
71	43	8,100*	8,100*	47	6,300*	6,300*	52	5,000*	5,000*	49	4,500*	4,500*	58	3,200*	3,200*	68	2,600*	2,600*	71
68	49	7,300*	6,900*	52	5,600*	5,200*	56	4,500*	4,500*	54	4,100*	4,100*	64	3,000*	3,000*	72	2,500*	2,500*	68
65	54	6,300*	5,700*	57	5,100*	4,300*	61	4,100*	3,900*	60	3,800*	3,800*	70	2,900*	2,900*	77	2,500*	2,500*	65
62	60	5,500*	4,800*	62	4,600*	3,500*	66	3,700*	3,100*	67	3,600*	3,600*	74	2,800*	2,800*	82	2,400*	2,400*	62
59	64	4,800*	4,000*	67	4,100*	2,800*	71	3,400*	2,600*	75	3,400*	3,000*	81	2,700*	2,700*	88	2,400*	2,400*	59
55	70	4,100*	3,000*	73	3,600*	2,100*	78	3,000*	1,900*	82	3,100*	2,300*	89	2,600*	2,100*	95	2,300*	1,900*	55
51	76	3,500*	2,300*	79	3,000*	1,400*	84	2,800*	1,400*	88	2,900*	1,700*	96	2,300*	1,500*	100	2,300*	1,400*	51
47	82	3,000*	1,700*	86	2,500*	900*	89	2,300*	900*	95	2,600*	1,300*	101	1,900*	1,100*	105	1,900*	1,100*	47
43	87	2,600*	1,200*	91	2,000*		93	1,900*		101	2,200*	900*	107	1,600*	800*	110	1,500*	800*	43
38	93	2,200*	700*	97	1,600*		98	1,500*		108	1,800*		113	1,300*		115	1,200*		38
32	100	1,600*		102	1,100*		104	1,100*		116	1,300*		119	900*		121	900*		32
25	106	1,000*		108	800*					125	900*		126	600*					25

#### NOTES FOR JIB CAPACITIES

- A. For all boom lengths less than the maximum with a jib erected, the rated loads are determined by boom angle only in the appropriate column.
- B. For boom angle not shown, use the capacity of the next lower boom angle.
- C. Listed radii are for extended main boom only.

### ON TIRES

RADIUS (FT)	MAX BOOM LENGTH (FT)	BOOM STRAIGHT OVER REAR 0 TO 2 1/2 MPH
10	30	13,400
12	30	11,300
15	39	8,700
20	39	5,300
25	50	3,100
30	50	2,000
35	50	1,000

#### NOTES FOR ON TIRE CAPACITIES

- A. For Pick and Carry operations, boom must be centered over the rear of the crane with swing brake and lock engaged. Use minimum boom point height and keep load close to ground surface.
- B. The load should be restrained from swinging. NO ON TIRE OPERATION WITH JIB ERECTED.
- C. Without outriggers, never maneuver the boom beyond listed load radii for applicable tires to ensure stability.
- D. Creep speed is crane movement of less than 200 Ft. (61m) in a 30 minute period and not exceeding 1.0 mph (1.6 km/h).
- E. Refer to General Notes for additional information.

### MAXIMUM PERMISSIBLE HOIST LINE LOAD

LINE PARTS	1	2	3	4	5	6	7
MAX. LOAD	9,080	18,160	27,240	36,320	45,400	54,480	63,560
BOOM HEAD	2	3-D	2-3	1-4-D	2-3-4	2-3-4-D	1-2-3-4
HOOK BLOCK	D	3	3-D	1-4	2-3-D	2-3-4	2-3-4-D
WIRE ROPE: 5/8" ROTATION RESISTANT COMPACTED STRAND, 18X19 OR 19X19 MINIMUM BREAKING STRENGTH - 22.7 TONS 5/8" 6X19 OR 6X37 IWRC IPS PREFORMED RIGHT REGULAR LAY MINIMUM BREAKING STRENGTH - 17.9 TONS							

# Lifting Capacities – Pounds (30’– 94’ boom and heavy-lift package)

## MODEL T 230

COUNTERWEIGHT:  
F. BUMPER 1850 LBS.  
UPPERSTRUCTURE:  
W/AUX. WINCH 6100 LBS.  
W/O AUX. WINCH 7200 LBS.

BOOM LENGTH 30-94 FT.  
STABILITY PCT.  
ON OUTRIGGERS 85%  
ON TIRES 75%  
PCSA CLASS 10-118

**CAUTION:** Do not use this specification sheet as a load rating chart. The format of data is not consistent with the machine chart and may be subject to change.

### ON OUTRIGGERS - FULLY EXTENDED

LOAD RADIUS (FT)	BOOM LENGTH 30 FT			BOOM LENGTH 39 FT			BOOM LENGTH 50 FT			LOAD RADIUS (FT)
	LOADED BOOM ANGLE (DEG)	OVER REAR (LB)	360° (LB)	LOADED BOOM ANGLE (DEG)	OVER REAR (LB)	360° (LB)	LOADED BOOM ANGLE (DEG)	OVER REAR (LB)	360° (LB)	
10	62.5	60,000*	60,000*	69.1	46,600*	46,600*				10
12	58.1	50,100*	50,100*	65.9	46,600*	46,600*	71.4	44,500*	44,500*	12
15	51.0	40,100*	40,100*	60.9	40,000*	40,000*	67.7	38,500*	38,500*	15
20	37.0	29,000*	29,000*	51.9	29,800*	29,800*	61.4	30,000*	30,000*	20
25	13.2	21,700*	21,700*	41.7	22,600*	22,600*	54.5	23,100*	23,100*	25
30	**			28.5	17,700*	17,700*	47.0	18,300*	18,300*	30
35				**			38.4	14,800*	14,800*	35
40							27.6	12,100*	11,800*	40
45							7.6	10,000*	9,300*	45
50							**			50
55										55
60										60
65										65
70										70
75										75
80										80
85										85

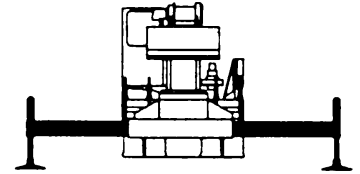

**USE THESE CHARTS ONLY  
WHEN ALL OUTRIGGERS  
ARE FULLY EXTENDED**

### ON OUTRIGGERS - FULLY EXTENDED

LOAD RADIUS (FT)	BOOM LENGTH 61 FT			BOOM LENGTH 72 FT			BOOM LENGTH 83 FT			BOOM LENGTH 94 FT			LOAD RADIUS (FT)
	LOADED BOOM ANGLE (DEG)	OVER REAR (LB)	360° (LB)	LOADED BOOM ANGLE (DEG)	OVER REAR (LB)	360° (LB)	LOADED BOOM ANGLE (DEG)	OVER REAR (LB)	360° (LB)	LOADED BOOM ANGLE (DEG)	OVER REAR (LB)	360° (LB)	
10													10
12													12
15	71.9	36,000*	36,000*										15
20	66.9	29,500*	29,500*	70.6	27,400*	27,400*							20
25	61.6	23,500*	23,500*	66.3	23,100*	23,100*	69.6	19,000*	19,000*	72.1	15,300*	15,300*	25
30	56.1	18,600*	18,600*	61.8	18,900*	18,900*	65.9	15,900*	15,900*	68.8	13,100*	13,100*	30
35	50.2	15,100*	15,100*	57.2	15,400*	15,400*	62.0	13,800*	13,800*	65.5	11,400*	11,400*	35
40	43.7	12,500*	12,200*	52.3	12,800*	12,400*	58.0	12,000*	12,000*	62.1	10,000*	10,000*	40
45	36.2	10,500*	9,800*	47.0	10,700*	9,900*	53.8	10,500*	10,100*	58.6	8,800*	8,800*	45
50	27.1	8,800*	7,900*	41.2	9,100*	8,100*	49.4	9,300*	8,200*	54.9	7,900*	7,900*	50
55	12.8	7,400*	6,400*	34.7	7,700*	6,700*	44.6	7,900*	6,800*	51.1	7,100*	6,900*	55
60	**			26.7	6,600*	5,500*	39.4	6,800*	5,700*	47.0	6,400*	5,800*	60
65				15.3	5,600*	4,500*	33.5	5,900*	4,800*	42.7	5,800*	4,900*	65
70				**			26.4	5,000*	3,900*	37.9	5,200*	4,100*	70
75							16.8	4,300*	3,300*	32.5	4,500*	3,400*	75
80							**			26.2	3,800*	2,800*	80
85										18.0	3,300*	2,300*	85

### \*\* MAXIMUM CAPACITY AT 0 DEGREE BOOM ANGLE

BOOM LENGTH 30 FT			BOOM LENGTH 39 FT			BOOM LENGTH 50 FT			BOOM LENGTH 61 FT			BOOM LENGTH 72 FT			BOOM LENGTH 83 FT			BOOM LENGTH 94 FT		
LOAD RADIUS (FT)	OVER REAR (LB)	360° (LB)	LOAD RADIUS (FT)	OVER REAR (LB)	360° (LB)	LOAD RADIUS (FT)	OVER REAR (LB)	360° (LB)	LOAD RADIUS (FT)	OVER REAR (LB)	360° (LB)	LOAD RADIUS (FT)	OVER REAR (LB)	360° (LB)	LOAD RADIUS (FT)	OVER REAR (LB)	360° (LB)	LOAD RADIUS (FT)	OVER REAR (LB)	360° (LB)
25.6	20,800*	20,800*	34.3	14,400*	14,400*	45.3	9,900*	9,100	56.3	7,100*	6,000	67.3	5,200*	4,100	78.3	3,800*	2,800	89.3	2,800*	1,900

# Lifting Capacities – Pounds (30’– 94’ boom and heavy-lift package)

## MODEL T 230

COUNTERWEIGHT:  
F. BUMPER 1850 LBS.  
UPPERSTRUCTURE:  
W/AUX. WINCH 6100 LBS.  
W/O AUX. WINCH 7200 LBS.

BOOM LENGTH 30-94 FT.  
STABILITY PCT.  
ON OUTRIGGERS 85%  
ON TIRES 75%  
PCSA CLASS 10-118

**CAUTION:** Do not use this specification sheet as a load rating chart. The format of data is not consistent with the machine chart and may be subject to change.

### ON OUTRIGGERS - MID POSITION

LOAD RADIUS (FT)	BOOM LENGTH 30 FT		BOOM LENGTH 39 FT		BOOM LENGTH 50 FT		BOOM LENGTH 61 FT		BOOM LENGTH 72 FT		BOOM LENGTH 83 FT		BOOM LENGTH 94 FT		LOAD RADIUS (FT)
	LOADED BOOM ANGLE (DEG)	360° (LB)	LOADED BOOM ANGLE (DEG)	360° (LB)	LOADED BOOM ANGLE (DEG)	360° (LB)	LOADED BOOM ANGLE (DEG)	360° (LB)	LOADED BOOM ANGLE (DEG)	360° (LB)	LOADED BOOM ANGLE (DEG)	360° (LB)	LOADED BOOM ANGLE (DEG)	360° (LB)	
10	62.5	55,700*	69.1	46,600*											10
12	58.1	50,100*	65.9	46,600*	71.4	44,500*									12
15	51.0	36,200	60.9	37,000	67.7	37,500	71.9	36,000*							15
20	37.0	20,000	51.9	21,000	61.4	21,400	66.9	21,700	70.6	21,900					20
25	13.2	12,600	41.7	13,600	54.5	14,200	61.6	14,500	66.3	14,600	69.6	14,800	72.1	14,900	25
30	**		28.5	9,400	47.0	10,100	56.1	10,300	61.8	10,500	65.9	10,600	68.8	10,700	30
35			**		38.4	7,300	50.2	7,700	57.2	7,800	62.0	8,000	65.5	8,000	35
40					27.6	5,400	43.7	5,800	52.3	6,000	58.0	6,100	62.1	6,200	40
45					7.6	3,900	36.2	4,300	47.0	4,600	53.8	4,700	58.6	4,800	45
50					**		27.1	3,200	41.2	3,500	49.4	3,600	54.9	3,700	50
55							12.8	2,300	34.7	2,600	44.6	2,800	51.1	2,900	55
60							**		26.7	1,900	39.4	2,100	47.0	2,200	60

### \*\* MAXIMUM CAPACITY AT 0 DEGREE BOOM ANGLE

BOOM LENGTH 30 FT		BOOM LENGTH 39 FT		BOOM LENGTH 50 FT		BOOM LENGTH 61 FT		BOOM LENGTH 72 FT		BOOM LENGTH 83 FT		BOOM LENGTH 94 FT	
LOAD RADIUS (FT)	360° (LB)	LOAD RADIUS (FT)	360° (LB)	LOAD RADIUS (FT)	360° (LB)	LOAD RADIUS (FT)	360° (LB)	LOAD RADIUS (FT)	360° (LB)	LOAD RADIUS (FT)	360° (LB)	LOAD RADIUS (FT)	360° (LB)
25.6	11,800	34.3	6,800	45.3	3,800	56.3	2,100						

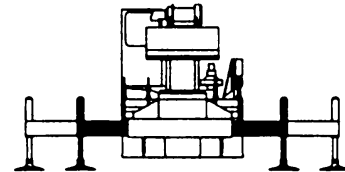

**USE THESE CHARTS  
ONLY WHEN ALL  
OUTRIGGERS ARE PINNED  
IN MID POSITION**

### ON OUTRIGGERS - RETRACTED

LOAD RADIUS (FT)	BOOM LENGTH 30 FT		BOOM LENGTH 39 FT		BOOM LENGTH 50 FT		BOOM LENGTH 61 FT		BOOM LENGTH 72 FT		BOOM LENGTH 83 FT		BOOM LENGTH 94 FT		LOAD RADIUS (FT)
	LOADED BOOM ANGLE (DEG)	360° (LB)	LOADED BOOM ANGLE (DEG)	360° (LB)	LOADED BOOM ANGLE (DEG)	360° (LB)	LOADED BOOM ANGLE (DEG)	360° (LB)	LOADED BOOM ANGLE (DEG)	360° (LB)	LOADED BOOM ANGLE (DEG)	360° (LB)	LOADED BOOM ANGLE (DEG)	360° (LB)	
10	62.5	31,000	69.1	31,700											10
12	58.1	22,100	65.9	22,800	71.4	23,300									12
15	51.0	14,500	60.9	15,400	67.7	15,800	71.9	16,100							15
20	37.0	8,000	51.9	8,800	61.4	9,400	66.9	9,700	70.6	9,800					20
25	13.2	4,400	41.7	5,400	54.5	5,900	61.6	6,200	66.3	6,400	69.6	6,500	72.1	6,600	25
30	**		28.5	3,100	47.0	3,700	56.1	4,100	61.8	4,300	65.9	4,400	68.8	4,500	30
35			**		38.4	2,200	50.2	2,610	57.2	2,800	62.0	2,900	65.5	3,000	35
40									52.3	1,700	58.0	1,900	62.1	2,000	40

### \*\* MAXIMUM CAPACITY AT 0 DEGREE BOOM ANGLE

BOOM LENGTH 30 FT		BOOM LENGTH 39 FT		BOOM LENGTH 50 FT		BOOM LENGTH 61 FT		BOOM LENGTH 72 FT		BOOM LENGTH 83 FT		BOOM LENGTH 94 FT	
LOAD RADIUS (FT)	360° (LB)	LOAD RADIUS (FT)	360° (LB)	LOAD RADIUS (FT)	360° (LB)	LOAD RADIUS (FT)	360° (LB)	LOAD RADIUS (FT)	360° (LB)	LOAD RADIUS (FT)	360° (LB)	LOAD RADIUS (FT)	360° (LB)
25.6	4,000	34.3	1,700										

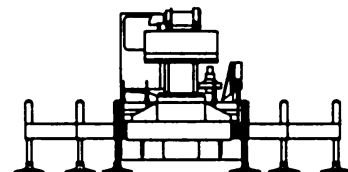

**USE THESE CHARTS WHEN  
ALL OUTRIGGER BEAMS ARE  
NOT IN EITHER THE MID OR  
FULLY EXTENDED POSITION**

# Lifting Capacities – Pounds (30'– 94' boom and heavy-lift package)

## MODEL T 230

COUNTERWEIGHT:  
F. BUMPER 1850 LBS.  
UPPERSTRUCTURE:  
W/AUX. WINCH 6100 LBS.  
W/O AUX. WINCH 7200 LBS.

BOOM LENGTH 30-94 FT.  
STABILITY PCT.  
ON OUTRIGGERS 85%  
ON TIRES 75%  
PCSA CLASS 10-118



**CAUTION:** Do not use this specification sheet as a load rating chart. The format of data is not consistent with the machine chart and may be subject to change.

### SIDE STOW JIB ON FULLY EXTENDED OUTRIGGERS

LOADED BOOM ANGLE (DEG)	26 FT OFFSETABLE JIB									43 FT OFFSETABLE JIB									LOADED BOOM ANGLE (DEG)
	0° OFFSET			15° OFFSET			30° OFFSET			0° OFFSET			15° OFFSET			30° OFFSET			
	LOAD RADIUS (REF) (FT)	REAR ONLY (LB)	360° (LB)	LOAD RADIUS (REF) (FT)	REAR ONLY (LB)	360° (LB)	LOAD RADIUS (REF) (FT)	REAR ONLY (LB)	360° (LB)	LOAD RADIUS (REF) (FT)	REAR ONLY (LB)	360° (LB)	LOAD RADIUS (REF) (FT)	REAR ONLY (LB)	360° (LB)	LOAD RADIUS (REF) (FT)	REAR ONLY (LB)	360° (LB)	
75	35	9,100*	9,100*	40	7,400*	7,400*	45	5,600*	5,600*	41	5,100*	5,100*	50	3,400*	3,400*	62	2,700*	2,700*	75
73	39	8,600*	8,600*	43	6,800*	6,800*	49	5,300*	5,300*	45	4,800*	4,800*	54	3,300*	3,300*	65	2,700*	2,700*	73
71	43	8,100*	8,100*	47	6,300*	6,300*	52	5,000*	5,000*	49	4,500*	4,500*	58	3,200*	3,200*	68	2,600*	2,600*	71
68	49	7,300*	7,300*	52	5,600*	5,600*	56	4,500*	4,500*	54	4,100*	4,100*	64	3,000*	3,000*	72	2,500*	2,500*	68
65	54	6,300*	6,300*	57	5,100*	5,100*	61	4,100*	4,100*	60	3,800*	3,800*	70	2,900*	2,900*	77	2,500*	2,500*	65
62	60	5,500*	5,500*	62	4,600*	4,600*	66	3,700*	3,700*	67	3,600*	3,600*	74	2,800*	2,800*	82	2,400*	2,400*	62
59	64	4,800*	4,800*	67	4,100*	4,100*	71	3,400*	3,400*	75	3,400*	3,400*	81	2,700*	2,700*	88	2,400*	2,400*	59
55	70	4,100*	3,900	73	3,600*	3,600*	78	3,000*	3,000*	82	3,100*	3,000	89	2,600*	2,500	95	2,300*	2,300*	55
51	76	3,700*	3,200	79	3,200*	3,000	84	2,800*	2,800*	88	2,900*	2,600	96	2,500*	2,200	100	2,300*	2,300*	51
47	82	3,200*	2,700	86	2,900*	2,500	89	2,500*	2,500*	95	2,600	2,200	101	2,400*	1,900	105	2,200*	1,900	47
43	87	2,800*	2,200	91	2,600*	2,100	93	2,400*	2,100	101	2,300	1,800	107	2,200	1,600	110	2,200*	1,600	43
38	93	2,200*	1,800	97	2,100*	1,700	98	2,000*	1,600	108	2,000	1,400	113	2,000	1,300	115	1,900*	1,300	38
32	100	1,900*	1,300	102	1,900*	1,300	104	1,800*	1,200	116	1,700	1,000	119	1,700	1,000	121	1,700*	1,000	32
25	106	1,600*	900	108	1,600*	900				125	1,200	700	126	1,200	600				25
17	112	1,400*	500	113	1,400*	500				132	800	500	133	800					17

#### NOTES FOR JIB CAPACITIES

- A. For all boom lengths less than the maximum with a jib erected, the rated loads are determined by boom angle only in the appropriate column.
- B. For boom angle not shown, use the capacity of the next lower boom angle.
- C. Listed radii are for extended main boom only.

### ON TIRES

RADIUS (FT)	MAX BOOM LENGTH (FT)	BOOM STRAIGHT OVER REAR 0 TO 2 1/2 MPH
10	30	18,900
12	30	15,800
15	39	12,100
20	39	7,800
25	50	5,300
30	50	3,600
35	50	2,600
40	50	1,800

#### NOTES FOR ON TIRE CAPACITIES

- A. For Pick and Carry operations, boom must be centered over the rear of the crane with swing brake and lock engaged. Use minimum boom point height and keep load close to ground surface.
- B. The load should be restrained from swinging. NO ON TIRE OPERATION WITH JIB ERECTED.
- C. Without outriggers, never maneuver the boom beyond listed load radii for applicable tires to ensure stability.
- D. Creep speed is crane movement of less than 200 Ft. (61m) in a 30 minute period and not exceeding 1.0 mph(1.6 km/h).
- E. Refer to General Notes for additional information.

### MAXIMUM PERMISSIBLE HOIST LINE LOAD

LINE PARTS	1	2	3	4	5	6	7
MAX. LOAD	9,080	18,160	27,240	36,320	45,400	54,480	63,560
BOOM HEAD	2	3-D	2-3	1-4-D	2-3-4	2-3-4-D	1-2-3-4
HOOK BLOCK	D	3	3-D	1-4	2-3-D	2-3-4	2-3-4-D
	WIRE ROPE: 5/8" ROTATION RESISTANT COMPACTED STRAND, 18X19 OR 19X19 MINIMUM BREAKING STRENGTH - 22.7 TONS 5/8" 6X19 OR 6X37 IWRC IPS PREFORMED RIGHT REGULAR LAY MINIMUM BREAKING STRENGTH - 17.9 TONS						

# GENERAL NOTES

## GENERAL

1. Rated loads as shown on Lift Charts pertain to this machine as originally manufactured and equipped. Modifications to the machine or use of optional equipment other than that specified can result in a reduction of capacity.
2. Construction equipment can be hazardous if improperly operated or maintained. Operation and maintenance of this machine shall be in compliance with the information in the Operator's, Parts and Safety Manuals supplied with this machine. If these manuals are missing, order replacements from the manufacturer through your distributor.
3. These warnings do not constitute all of the operating conditions for the crane. The operator and job site supervision must read the OPERATORS MANUAL, CIMA SAFETY MANUAL, APPLICABLE OSHA REGULATIONS, AND SOCIETY OF MECHANICAL ENGINEERS (ASME) SAFETY STANDARDS FOR CRANES.
4. This crane and its load ratings are in accordance with POWER CRANE & SHOVEL ASSOCIATION, STANDARD NO. 4, SAE CRANE LOAD STABILITY TEST CODE J765A, SAE METHOD OF TEST FOR CRANE STRUCTURE J1063 AND APPLICABLE SAFETY CODE FOR CRANES, DERRICKS AND HOISTS, ASME/ANSI B30.5.

## DEFINITIONS

1. **LOAD RADIUS** – The horizontal distance from the axis of rotation before loading to the center of the vertical hoist line or tackle with a load applied.
2. **LOADED BOOM ANGLE** – It is the angle between the boom base section and the horizontal, after lifting the rated load at the rated radius. The boom angle before loading should be greater to account for deflections. The loaded boom angle combined with boom length give only an approximation of the operating radius.
3. **WORKING AREA** – Areas measured in a circular arc about the center-line of rotation as shown in the diagram.
4. **FREELY SUSPENDED LOAD** – Load hanging free with no direct external force applied except by the hoist rope.
5. **SIDE LOAD** – Horizontal force applied to the lifted load either on the ground or in the air.
6. **NO LOAD STABILITY LIMIT** – The stability limit radius shown on the range diagrams is the radius beyond which it is not permitted to position the boom, when the boom angle is less than the minimum shown on the applicable load chart, because the machine can overturn without any load.
7. **BOOM SIDE OF CRANE** – The side of the crane over which the boom is positioned when in an OVER SIDE working position.

## SET-UP

1. Crane load ratings are based on the crane being leveled and standing on a firm, uniform supporting surface.
2. Crane load ratings on outriggers are based on all outrigger beams being fully extended or in the case of partial extension ratings mechanically pinned in the appropriate position, and the tires free of the supporting surface.
3. Crane load ratings on tires depend on appropriate inflation pressure and the tire conditions. Caution must be exercised when increasing air pressures in tires. Consult Operator's Manual for precautions.
4. Use of jibs, lattice-type boom extensions, or fourth section pullouts extended is not permitted for pick and carry operations.
5. Consult appropriate section of the Operator's and Service Manual for more exact description of hoist line reeving.
6. The use of more parts of line than required by the load may result in having insufficient rope to allow the hook block to reach the ground.
7. Properly maintained wire rope is essential for safe crane operation. Consult Operator's Manual for proper maintenance and inspection requirements.
8. When spin-resistant wire rope is used, the allowable rope loading shall be the breaking strength divided by five (5), unless otherwise specified by the wire rope manufacturer.
9. Do not elevate the boom above 65° unless the boom is positioned in-line with the crane's chassis or the outriggers are extended. Failure to observe this warning may result in loss of stability.

## OPERATION

1. **CRANE LOAD RATINGS MUST NOT BE EXCEEDED. DO NOT ATTEMPT TO TIP THE CRANE TO DETERMINE ALLOWABLE LOADS.**
2. When either radius or boom length, or both, are between listed values, the smaller of the two listed load ratings shall be used.
3. Do not operate at longer radii than those listed on the applicable load rating chart (cross hatched areas shown on range diagrams).
4. The boom angles shown on the Capacity Chart give an approximation of the operating radius for a specified boom length. The boom angle, before loading, should be greater to account for boom deflection. It may be necessary to retract the boom if maximum boom angle is insufficient to maintain rated radius.
5. Power telescoping boom sections must be extended equally.
6. Rated loads include the weight of hook block, slings, and auxiliary lifting devices. Their weights shall be subtracted from the listed rated load to obtain the net load that can be lifted.

When lifting over the jib the weight of any hook block, slings, and auxiliary lifting devices at the boom head must be added to the load.

When jibs are erected but unused add two (2) times the weight of any hook block, slings, and auxiliary lifting devices at the jib head to the load.

7. Rated loads do not exceed 85% on outriggers or 75% on tires, of the tipping load as determined by SAE Crane Stability Test Code J765a. Structural strength ratings in chart are indicated with an asterisk (\*).
8. Rated loads are based on freely suspended loads. No attempt shall be made to drag a load horizontally on the ground in any direction.
9. The user shall operate at reduced ratings to allow for adverse job conditions, such as: Soft or uneven ground, out of level conditions, high winds, side loads, pendulum action, jerking or sudden stopping of loads, hazardous conditions, experience of personnel, two machine lifts, traveling with loads, electric wires, etc., (side pull on boom or jib is hazardous). Derating of the cranes lifting capacity is required when wind speed exceeds 20 MPH. the center of the lifted load must never be allowed to move more than 3\* feet off the center line of the base boom section due to the effects of wind, inertia, or any combination of the two.

\*\*Use 2 feet off the center line of the base boom for a two section boom, 3 feet for a three section boom, or 4 feet for a four section boom."

10. The maximum load which can be telescoped is not definable, because of variations in loadings and crane maintenance, but it is permissible to attempt retraction and extension if load ratings are not exceeded.
11. Load ratings are dependent upon the crane being maintained according to manufacturer's specifications.
12. It is recommended that load handling devices, including hooks, and hook blocks, be kept away from boom head at all times.
13. **FOR TRUCK CRANES ONLY:** 360° capacities apply only to machines equipped with a front outrigger jack and all five (5) outrigger jacks properly set. If the front (5th) outrigger jack is not properly set, the work area is restricted to the over side and over rear areas as shown on the Crane Working Positions diagram. Use the 360° load ratings in the overside work areas.
14. Do not lift with outrigger beams positioned between the fully extended and intermediate (pinned) positions.
15. Truck Cranes not equipped with equalizing (bogie) beams between the rear axles may not be used for lifting "on tires". Truck Cranes equipped with equalizing beams and rear air suspension should "dump" the air before lifting "on tires".

## CLAMSHELL, MAGNET, AND CONCRETE BUCKET SERVICE

1. Maximum boom length for clamshell and magnet service is 50 feet.
2. Weight of clamshell or magnet, plus contents are not to exceed 6,000 pounds or 90% of rated lifting capacities, whichever is less. For concrete bucket operation, weight of bucket and load must not exceed 90% of rated lifting capacity.

WE RESERVE THE RIGHT TO AMEND THESE SPECIFICATIONS AT ANY TIME WITHOUT NOTICE. THE ONLY WARRANTY APPLICABLE IS OUR STANDARD WRITTEN WARRANTY APPLICABLE TO THE PARTICULAR PRODUCT AND SALE. WE MAKE NO OTHER WARRANTY, EXPRESSED OR IMPLIED.



# CUSTOM SERVICE CRANE, INC.

www.CustomServiceCrane.com | t: 217-897-1700 | Randy@customservicecrane.com