

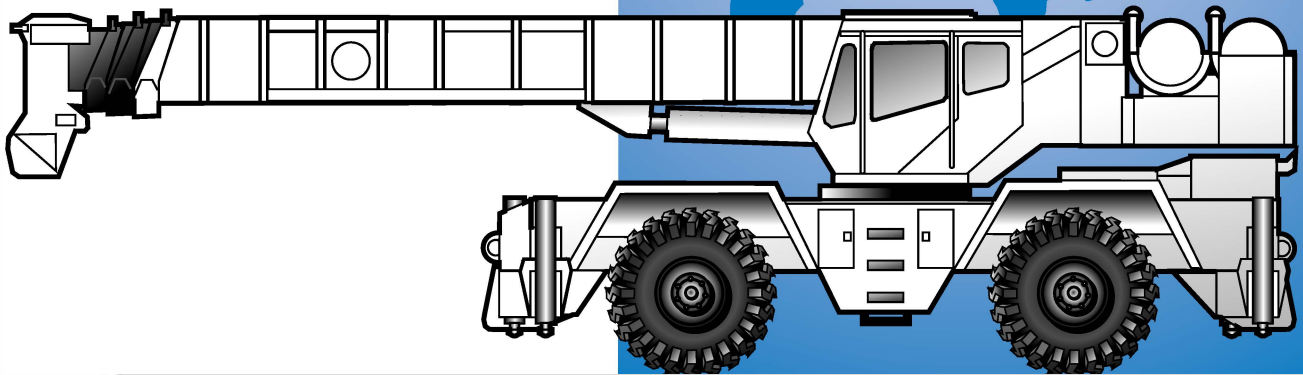

# RT855B



CUSTOM SERVICE CRANE, INC.



## Rough Terrain Hydraulic Crane



**CUSTOM SERVICE CRANE, INC.**

[www.CustomServiceCrane.com](http://www.CustomServiceCrane.com) | t: 217-897-1700 | [Randy@customservicecrane.com](mailto:Randy@customservicecrane.com)

# Dimensions

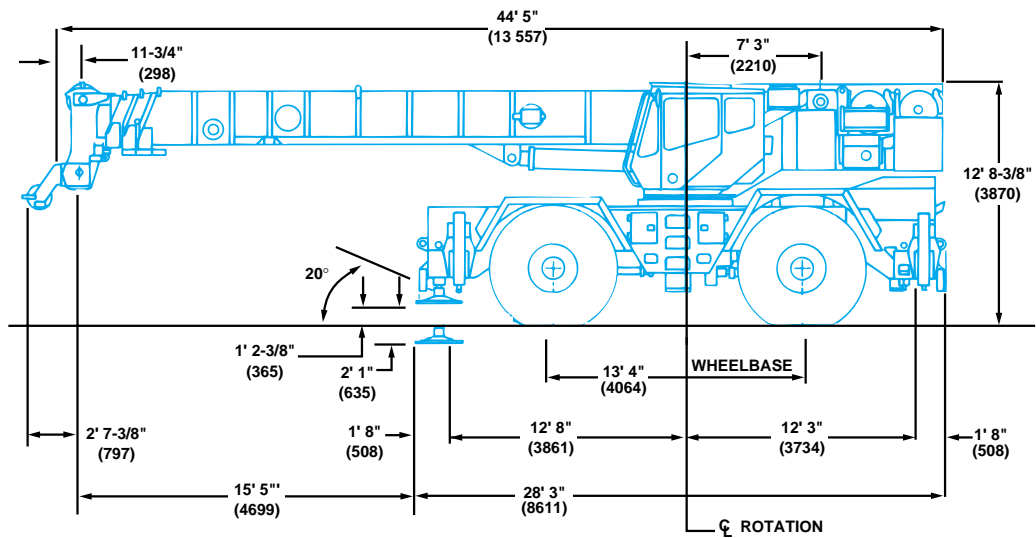
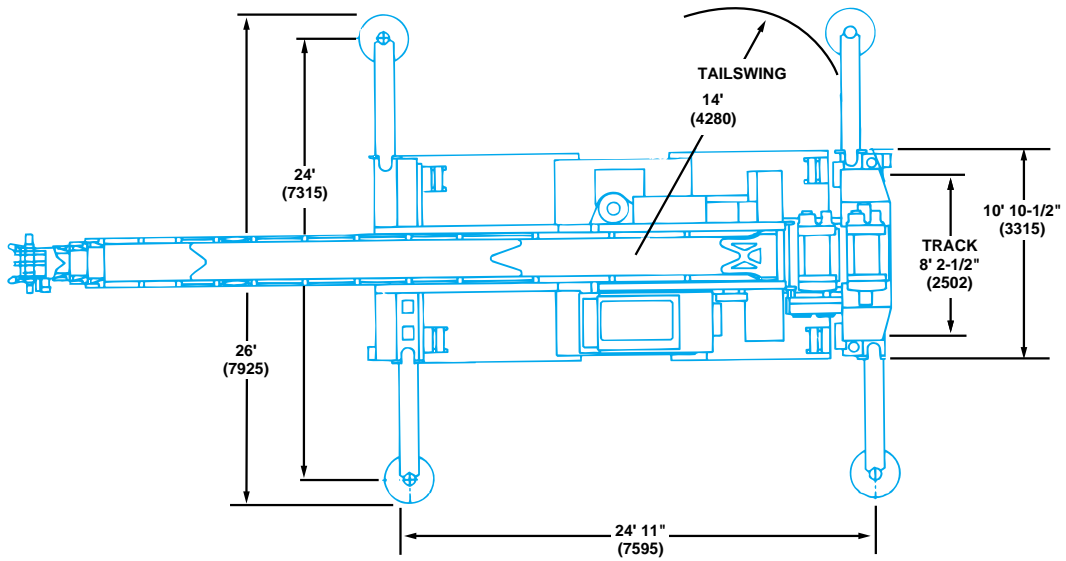

Note: ( ) Reference dimensions in mm

- Turning Radius** . . . . . 20' 7" (6274 mm)
- Front Axle Load** . . . . . 46,491 lbs. (21 088 kg)
- Rear Axle Load** . . . . . 46,176 lbs. (20 945 kg)
- Gross Vehicle Weight** . . . . . 92,667 lbs. (42 033 kg)

# Working Range



37 - 115 ft.  
(11.2 - 35 m)

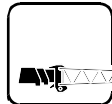

35 - 60 ft.  
(10.6 - 18.2 m)



9,500 lbs.  
(4309 kg)

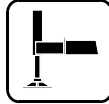

360°

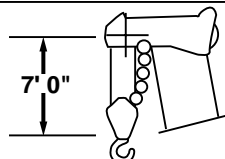
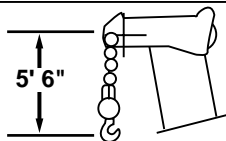
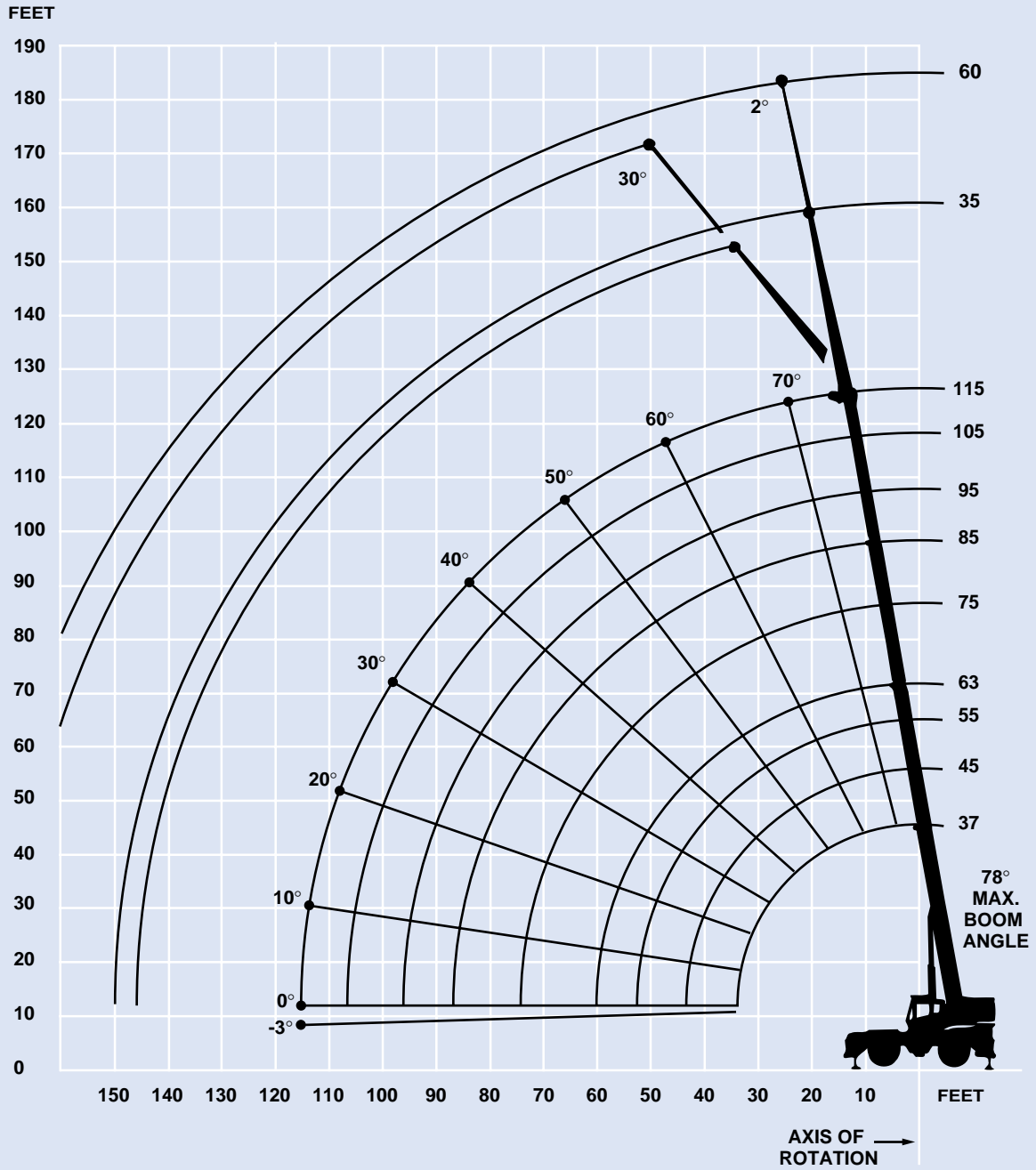

**DIMENSIONS ARE FOR LARGEST GROVE FURNISHED HOOK BLOCK AND HEADACHE BALL, WITH ANTI-TWO BLOCK ACTIVATED.**

# Superstructure specifications

## Boom

37 ft. - 115 ft. (11.2 m - 35 m) four-section full power boom. Maximum tip height: 125 ft. (38.0 m).

## \*Optional Boom

37 ft. - 89 ft. (11.2 m - 27 m) three-section full power boom. Maximum tip height: 99 ft. (30.0 m).

## Lattice Extension

35 ft. - 60 ft. (10.6 m - 18.2 m) telescoping lattice swingaway extension offsettable at 0° or 30°.

Stows alongside base boom section.

Maximum tip height: 184 ft. (56 m).

## \*Optional Lattice Extension

35 ft. (10.6 m) lattice swingaway extension. Offsettable at 2° or 30°. Stows alongside base boom section.

Maximum tip height: 159 ft. (48.5 m).

## Boom Nose

Four nylatron sheaves mounted on heavy duty tapered roller bearings with removable pin-type rope guards. Quick reeving type boom nose. Removable auxiliary boom nose with removable pin type rope guard.

## Boom Elevation

One double acting hydraulic cylinder with integral holding valve provides elevation from -3° to 78°.

## Load Moment & Anti-Two Block System

Standard load moment and anti-two block system with audio-visual warning and control lever lockout. These systems provide electronic display of boom angle, length, radius, tip height, relative load moment, maximum permissible load and load indication and warning of impending two-block condition.

## Cab

Full vision, all galvanealed steel fabricated with acoustical lining and tinted safety glass throughout. Deluxe seat with armrest mounted hydraulic single axis controllers. Dash panel incorporates gauges for engine functions. Other standard features include: skylight screen, hydraulic oil cab heater/defroster, telescoping, tilt wheel, sliding side and rear windows, opening skylight, electric windshield wash-wipe, electric skylight wipers, fire extinguisher, seat belt, ashtray and level indicator.

## Swing

Planetary swing with foot applied multi-disc wet brake. Spring applied, hydraulically released swing brake, 360° positive swing lock (N.Y.C. style) and 1 position, mechanical house lock, operated from cab. Maximum speed: 2.0 RPM.

## Counterweight

Removable: 9,500 lbs. (4309 kg).

2,155 lbs. (977 kg) slab in place of auxiliary hoist.

## Hydraulic System

Seven main pumps with a combined capacity 199.2 GPM (754 LPM).

Maximum operating pressure: 3500 PSI (241 bar).

Three individual valve banks.

Return line type filter with full flow by-pass protection and service indicator. Replaceable cartridge with micron filtration rating of 5/12/16.

200 gallons (757 L) reservoir. Remote mounted oil cooler with thermostatically controlled hydraulic motor driven fan/air to oil.

System pressure test panel with quick release type fittings for each circuit.

## Hoist Specifications Main and Auxiliary Hoist

Planetary reduction with automatic spring applied multi-disc brake. Electronic hoist drum rotation indicator, hoist drum cable followers and wire rope.

Maximum Single Line Pull: 16,969 lbs.  
(7697 kg)

Maximum Single Line Speed: 517 FPM  
(157 m/min)

Maximum Permissible  
Line Pull: 12,920 lbs.  
(5860 kg)

Rope Diameter: 3/4 in.  
(19 mm)

Rope Length: 550 ft.  
(167 m)

Maximum Rope Stowage: 1,163 ft.  
(354.5 m)

*\*Denotes optional equipment*

# Carrier specifications

## Chassis

Box section frame fabricated from high-strength, low alloy steel. Integral outrigger housings and front/rear towing and tie down lugs.

## Outrigger System

Four hydraulic telescoping single-stage double box beam outriggers with inverted jacks and integral holding valves. Three position setting. All steel fabricated quick release type outrigger floats, 24" (610 mm) diameter.

Maximum outrigger pad load: 92,575 lbs. (41 992 kg).

## Outrigger Controls

Controls and crane level indicator located in cab.

## Engine

Cummins 6CTA 8.3 diesel, six cylinders, turbocharged, 250 bhp (186 kW) (Gross) @ 2,200 RPM.

Maximum torque: 794 ft. lbs. (1077 Nm) @ 1,800 RPM.

## \*Optional Engine

Caterpillar 3126TA diesel, six cylinders, turbocharged, 250 bhp (186 kW) (Gross) @ 2,500 RPM.

Maximum torque: 686 ft. lbs. (930 Nm) @ 1,600 RPM.

## Fuel Tank Capacity

80 gallons (303 L)

## Transmission

Full powershift with 6 forward and 6 reverse speeds.

Rear axle disconnect for 4 x 2 travel.

## Electrical System

Two 12 V - maintenance free batteries. 24 V starting and lighting.

## Drive

4 x 4.

## Steering

Fully independent power steering:

Front: Full hydraulic steering wheel controlled.

Rear: Full hydraulic hand lever controlled.

Provides infinite variations of 4 main steering modes: front only, rear only, crab and coordinated.

Rear steer indicating gauge.

## Axles

Front: Drive steer with differential and planetary reduction hubs rigid mounted to frame.

Rear: Drive/steer with differential and planetary reduction hubs pivot mounted to frame.

Automatic full hydraulic lockouts on rear axle.

## Oscillation Lockouts

Automatic full hydraulic lockouts on rear axle permits oscillation only with boom centered over the front.

## Brakes

Full air split circuit operating on all wheels. Spring-applied, air released front and rear axles.

## Tires

Std. 29.5x25 - 28PR earthmover type.

\*Optional: 29.5R25 radial.

## Lights

Full lighting including turn indicators, head, tail, brake, and hazard warning lights.

## Maximum Speed

25 MPH (40 kph).

## Gradeability (Theoretical)

74% (Based on 92,667 lbs. [42 033 kg] GVW) 29.5x25 tires, pumps disengaged, 115 ft. (35 m) boom, plus 35 ft. (10.6 m) swingaway.

## Miscellaneous Standard Equipment

Full width steel fenders, dual rear view mirrors, hook-block tiedown, electronic back-up alarm, light package, front stowage well, tachometer/hourmeter, cold start aid (less canister), rear wheel position indicator, hydraulic cab heater, hoist mirrors, engine distress A/V warning system, tire inflation kit.

## \*Optional Equipment

- |  |  |
|--|--|
| *Boom mounted worklights   | *Dual axis joystick controllers          |
| *360° flashing light   | *Air conditioning                        |
| *Cab spotlights remote mounted   | *Auxiliary oil cooler                    |
| *Engine block heater   | *Emergency steer pump                    |
| *Hookblocks (quick reeving type)   | *Propane heater                          |
| *Tow winch - front mounted maximum pull: 15,000 lbs. (6804 kg); maximum speed: 92 ft/min. (28m/min). | *T/T lube system                         |
| *Spare tire & wheel assembly   | *Hoist mounted work light system         |
| *Tool kit  | *Counterweight removal system            |
| *Pintle hook front/rear  | *3rd wrap indicators (main or auxiliary) |
| *High Speed Glide system   | *LMI light bar                           |
|  | *Cross axle differential locks           |
|  | *Oscillation lockout override control    |

*\*Denotes optional equipment*



37 - 115 ft.  
(11.2 - 35 m)



9,500 lbs.  
(4309 kg)



100%



360°



(Pounds)

(Feet)	37	45	55	*63	75	85	95	105	115
10	+110,000 (69)	86,600 (73)	75,550 (76.5)						
12	97,800 (65.5)	86,600 (70.5)	75,550 (74.5)	60,950 (76.5)					
15	86,500 (59.5)	81,050 (66)	75,550 (71)	60,950 (73.5)	44,100 (77)				
20	68,950 (49.5)	67,500 (58.5)	64,000 (65)	58,950 (68.5)	44,100 (73)	43,450 (75.5)	40,400 (77.5)		
25	54,900 (36.5)	54,200 (50)	53,400 (59)	49,100 (63.5)	40,200 (68.5)	36,750 (71.5)	34,350 (74)	30,600 (76)	@24,450 (78)
30		41,950 (40)	41,400 (52)	41,050 (58)	34,800 (64.5)	31,650 (68)	29,450 (71)	27,350 (73.5)	22,200 (75.5)
35		33,550 (26)	33,000 (44.5)	32,700 (52)	30,550 (60)	27,650 (64)	25,700 (67.5)	24,250 (70.5)	19,900 (72.5)
40			26,900 (35.5)	26,600 (46)	27,100 (55)	24,500 (60.5)	22,650 (64)	21,300 (67.5)	17,800 (70)
45			21,100 (23.5)	20,850 (38.5)	22,200 (50)	21,850 (56)	20,150 (60.5)	18,900 (64.5)	16,000 (67)
50				16,550 (29)	17,850 (44.5)	18,950 (51.5)	18,050 (57)	16,900 (61)	14,550 (64.5)
55				13,250 (13.5)	14,550 (38)	15,600 (47)	16,250 (53)	15,200 (57.5)	13,250 (61.5)
60					12,000 (30.5)	12,950 (42)	13,550 (49)	13,750 (54.5)	12,300 (58.5)
65					9,940 (20)	10,800 (36)	11,400 (44.5)	11,950 (50.5)	11,350 (55.5)
70						9,050 (29)	9,620 (39.5)	10,150 (46.5)	10,450 (52)
75						7,560 (19)	8,100 (34)	8,650 (42.5)	9,200 (48.5)
80							6,840 (27.5)	7,360 (38)	7,890 (45)
85							5,780 (18)	6,270 (32.5)	6,760 (41)
90								5,310 (26.5)	5,770 (36.5)
95								4,470 (17.5)	4,900 (31.5)
100									4,130 (25.5)
105									3,440 (17)

Maximum boom length (ft.) at 0 deg. boom angle (no load)

0

Minimum boom angle (deg.) for indicated length (no load)

115

NOTE: ( ) Boom angles are in degrees.

\*63 ft. boom length is with inner-mid extended and outer-mid and fly retracted.

+9 parts of line required to lift this capacity (using aux.boom nose).

@This capacity is based on maximum boom angle.

Boom Angle	37	45	55	*63	75	85	95	105	115
0°	24,400 (29.8)	17,750 (37.8)	12,200 (47.8)	9,000 (55.8)	6,820 (67.8)	5,470 (77.8)	4,400 (87.8)	3,540 (97.8)	2,820 (107.8)

A6-829-011790C



37 - 115 ft.  
(11.2 - 35 m)



9,500 lbs.  
(4309 kg)



50%



360°



(Feet)	37	45	55	*63	75	85	95	105	115
10	+110,000 (69)	86,600 (73)	75,550 (76.5)						
12	97,800 (65.5)	86,600 (70.5)	75,550 (74.5)	60,950 (76.5)					
15	86,500 (59.5)	81,050 (66)	75,550 (71)	60,950 (73.5)	44,100 (77)				
20	60,750 (49.5)	56,900 (58.5)	53,200 (65)	50,650 (68.5)	44,100 (73)	43,450 (75.5)	40,400 (77.5)		
25	41,400 (36.5)	39,350 (50)	36,850 (59)	35,250 (63.5)	35,450 (68.5)	35,300 (71.5)	34,350 (74)	30,600 (76)	@24,450 (78)
30		28,750 (40)	27,150 (52)	25,900 (58)	26,550 (64.5)	26,700 (68)	26,750 (71)	26,650 (73.5)	22,200 (75.5)
35		21,150 (26)	20,700 (44.5)	19,700 (52)	20,500 (60)	20,850 (64)	21,050 (67.5)	21,150 (70.5)	19,900 (72.5)
40			15,850 (35.5)	15,200 (46)	16,150 (55)	16,650 (60.5)	16,950 (64)	17,100 (67.5)	17,200 (70)
45			12,100 (23.5)	11,900 (38.5)	12,900 (50)	13,400 (56)	13,800 (60.5)	14,000 (64.5)	14,200 (67)
50				9,210 (29)	10,300 (44.5)	10,900 (51.5)	11,300 (57)	11,600 (61)	11,800 (64.5)
55				6,990 (13.5)	8,150 (38)	8,890 (47)	9,320 (53)	9,640 (57.5)	9,870 (61.5)
60					6,390 (30.5)	7,220 (42)	7,680 (49)	8,020 (54.5)	8,270 (58.5)
65					4,950 (20)	5,760 (36)	6,290 (44.5)	6,660 (50.5)	6,930 (55.5)
70						4,490 (29)	5,000 (39.5)	5,500 (46.5)	5,780 (52)
75						3,410 (19)	3,920 (34)	4,420 (42.5)	4,790 (48.5)
80							3,000 (27.5)	3,480 (38)	3,930 (45)
85							2,230 (18)	2,690 (32.5)	3,140 (41)
90								1,980 (26.5)	2,410 (36.5)
95								1,360 (17.5)	1,760 (31.5)
100									1,190 (25.5)
Minimum boom angle (deg.) for indicated length (no load)									11.5
Maximum boom length (ft.) at 0 deg. boom angle (no load)									105

NOTE: ( ) Boom angles are in degrees.

\*63 ft. boom length is with inner-mid extended and outer-mid and fly retracted.

+9 parts of line required to lift this capacity (using auxiliary boom nose).

@This capacity is based on maximum boom angle.

Boom Angle	37	45	55	*63	75	85	95	105
0°	24,400 (29.8)	17,750 (37.8)	10,450 (47.8)	6,700 (55.8)	4,260 (67.8)	2,880 (77.8)	1,850 (87.8)	1,050 (97.8)

A6-829-011791C



37 - 115 ft.  
(11.2 - 35 m)



9,500 lbs.  
(4309 kg)



0%



360°



(Pounds)

(Feet)	37	45	55	*63	75	85	95	105	115
10	82,900 (69)	76,200 (73)	69,350 (76.5)						
12	63,000 (65.5)	58,400 (70.5)	53,700 (74.5)	50,500 (76.5)					
15	45,250 (59.5)	42,150 (66)	39,000 (71)	36,900 (73.5)	36,450 (77)				
20	28,150 (49.5)	27,200 (58.5)	25,200 (65)	23,900 (68.5)	24,250 (73)	24,300 (75.5)	24,150 (77.5)		
25	18,300 (36.5)	17,900 (50)	17,350 (59)	16,350 (63.5)	17,100 (68.5)	17,400 (71.5)	17,500 (74)	17,500 (76)	@17,450 (78)
30		12,200 (40)	11,900 (52)	11,400 (58)	12,350 (64.5)	12,800 (68)	13,050 (71)	13,200 (73.5)	13,300 (75.5)
35		8,590 (26)	8,360 (44.5)	7,980 (52)	8,990 (60)	9,520 (64)	9,890 (67.5)	10,100 (70.5)	10,250 (72.5)
40			5,820 (35.5)	5,410 (46)	6,480 (55)	7,060 (60.5)	7,480 (64)	7,780 (67.5)	7,980 (70)
45			3,920 (23.5)	3,430 (38.5)	4,530 (50)	5,150 (56)	5,600 (60.5)	5,940 (64.5)	6,180 (67)
50				1,860 (29)	2,980 (44.5)	3,620 (51.5)	4,100 (57)	4,460 (61)	4,730 (64.5)
55					1,720 (38)	2,380 (47)	2,870 (53)	3,240 (57.5)	3,530 (61.5)
60						1,340 (42)	1,840 (49)	2,230 (54.5)	2,530 (58.5)
65								1,370 (50.5)	1,680 (55.5)

Minimum boom angle (deg.) for indicated length (no load)

52.5

Maximum boom length (ft.) at 0 deg. boom angle (no load)

55

NOTE: ( ) Boom angles are in degrees.

\*63 ft. boom length is with inner-mid extended and outer-mid and fly retracted.

@This capacity is based on maximum boom angle.

Boom Angle	37	45	55
0°	12,600 (29.8)	7,080 (37.8)	3,060 (47.8)

A6-829-011902B





37 - 115 ft.  
(11.2 - 35 m)



35 - 60 ft.  
(10.6 - 18.2 m)



9,500 lbs.  
(4309 kg)



100%



360°



(Pounds)

(Feet)	35 ft. LENGTH		60 ft. LENGTH	
	2° OFFSET	30° OFFSET	2° OFFSET	30° OFFSET
35	*12,900 (78)			
40	11,900 (75.5)		*6,700 (78)	
45	11,150 (73.5)		6,500 (77.5)	
50	10,450 (71.5)	7,500 (77)	6,400 (76)	
55	9,870 (69.5)	7,310 (74.5)	6,300 (74)	
60	9,340 (67.5)	7,150 (72.5)	6,200 (72.5)	
65	8,850 (65)	7,010 (70.5)	6,100 (70.5)	
70	8,420 (63)	6,880 (68)	6,000 (69)	4,000 (77)
75	8,020 (60.5)	6,760 (66)	5,670 (67)	3,680 (75)
80	7,660 (58.5)	6,650 (63.5)	5,340 (65)	3,500 (73.5)
85	7,330 (56)	6,560 (61)	5,010 (63.5)	3,350 (71.5)
90	6,490 (53.5)	6,470 (58.5)	4,680 (61.5)	3,280 (69.5)
95	5,550 (51)	5,550 (56)	4,350 (59.5)	3,220 (67)
100	4,720 (48.5)	4,720 (53)	4,000 (57.5)	3,160 (65)
105	3,980 (45.5)	3,980 (50)	3,670 (55)	3,100 (63)
110	3,310 (42.5)	3,310 (47)	3,340 (53)	3,050 (60.5)
115	2,710 (39.5)	2,710 (43.5)	3,070 (51)	3,000 (58)
120	2,170 (36)	2,170 (40)	2,950 (48.5)	2,960 (55.5)
125	1,670 (32.5)	1,670 (36)	2,840 (46)	2,930 (53)
130	1,220 (28)	1,220 (31)	2,730 (43.5)	2,730 (50.5)
135			2,280 (41)	2,280 (47.5)
140			1,860 (38)	1,860 (44.5)
145			1,470 (35)	1,470 (41)
150			1,110 (31.5)	1,110 (37)

NOTE: ( ) Boom angles are in degrees.

\*This capacity is based upon maximum boom angle.

A6-829-011795B



37 - 115 ft.  
(11.2 - 35 m)

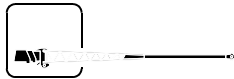

35 - 60 ft.  
(10.6 - 18.2 m)



9,500 lbs.  
(4309 kg)



50%



360°



(Pounds)

(Feet)	35 ft. LENGTH		60 ft. LENGTH	
	2° OFFSET	30° OFFSET	2° OFFSET	30° OFFSET
35	*12,900 (78)			
40	11,900 (75.5)		*6,700 (78)	
45	11,150 (73.5)		6,270 (77.5)	
50	10,450 (71.5)	7,500 (77)	5,860 (76)	
55	9,150 (69.5)	7,310 (74.5)	5,510 (74)	
60	7,620 (67.5)	7,150 (72.5)	5,180 (72.5)	
65	6,330 (65)	6,330 (70.5)	4,900 (70.5)	
70	5,230 (63)	5,230 (68)	4,630 (69)	4,000 (77)
75	4,270 (60.5)	4,270 (66)	4,400 (67)	3,680 (75)
80	3,430 (58.5)	3,430 (63.5)	4,180 (65)	3,500 (73.5)
85	2,690 (56)	2,690 (61)	3,920 (63.5)	3,350 (71.5)
90	2,040 (53.5)	2,040 (58.5)	3,270 (61.5)	3,270 (69.5)
95	1,450 (51)	1,450 (56)	2,690 (59.5)	2,690 (67)
100			2,170 (57.5)	2,170 (65)
105			1,690 (55)	1,690 (63)
110			1,260 (53)	1,260 (60.5)

NOTE: ( ) Boom angles are in degrees.

\*This capacity is based upon maximum boom angle.

A6-829-011796D



37 - 115 ft.  
(11.2 - 35 m)

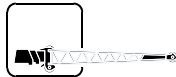

35 ft.  
(10.6 m)



9,500 lbs.  
(4309 kg)



100%



360°



35 ft. LENGTH

(Feet)	2° OFFSET	30° OFFSET
35	*12,900 (78)	
40	12,200 (75.5)	
45	11,450 (73.5)	
50	10,750 (71.5)	7,800 (77)
55	10,150 (69.5)	7,610 (74.5)
60	9,640 (67.5)	7,450 (72.5)
65	9,150 (65)	7,310 (70.5)
70	8,720 (63)	7,180 (68)
75	8,320 (60.5)	7,060 (66)
80	7,960 (58.5)	6,950 (63.5)
85	7,630 (56)	6,860 (61)
90	6,970 (53.5)	6,770 (58.5)
95	6,040 (51)	6,040 (56)
100	5,210 (48.5)	5,210 (53)
105	4,470 (45.5)	4,470 (50)
110	3,800 (42.5)	3,800 (47)
115	3,200 (39.5)	3,200 (43.5)
120	2,660 (36)	2,660 (40)
125	2,160 (32.5)	2,160 (36)
130	1,710 (28)	
135	1,290 (23)	

NOTE: ( ) Boom angles are in degrees.

@This capacity is based on maximum boom angle.

A6-829-012129A



37 - 115 ft.  
(11.2 - 35 m)

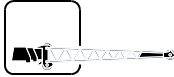

35 ft.  
(10.6 m)



9,500 lbs.  
(4309 kg)



50%



360°



(Pounds)

35 ft. LENGTH

(Feet)	2° OFFSET	30° OFFSET
35	*12,900 (78)	
40	12,200 (75.5)	
45	11,450 (73.5)	
50	10,750 (71.5)	7,800 (77)
55	9,720 (69.5)	7,610 (74.5)
60	8,190 (67.5)	7,450 (72.5)
65	6,900 (65)	6,900 (70.5)
70	5,800 (63)	5,800 (68)
75	4,840 (60.5)	4,840 (66)
80	4,010 (58.5)	4,010 (63.5)
85	3,270 (56)	3,270 (61)
90	2,620 (53.5)	2,620 (58.5)
95	2,030 (51)	2,030 (56)
100	1,510 (48.5)	1,510 (53)
105	1,030 (45.5)	1,030 (50)

NOTE: ( ) Boom angles are in degrees.

@This capacity is based on maximum boom angle.

A6-829-012145C



37 - 115 ft.  
(11.2 - 35.0 m)



9,500 lbs.  
(4309 kg)



Stationary  
29.5 x 25 - 28PR Tires



Defined Arc  
Over Front



(Pounds)

(Feet)	37	45	55	*63	75	85	95
10	44,100 (68.5)	39,100 (73)					
12	44,100 (65)	39,100 (70)	29,950 (74)	23,800 (76.5)			
15	42,800 (59.5)	39,100 (65.5)	29,950 (70.5)	23,800 (73.5)	19,400 (76.5)		
20	34,100 (49)	30,000 (58)	27,600 (65)	23,800 (68.5)	19,400 (72.5)	15,950 (75)	
25	26,100 (36)	23,500 (49.5)	22,250 (58.5)	19,900 (63.5)	19,400 (68)	15,950 (71)	15,500 (73.5)
30		18,650 (39.5)	17,850 (52)	16,450 (58)	15,750 (64)	14,750 (67.5)	13,750 (70.5)
35		13,650 (26)	13,300 (44.5)	13,000 (52)	12,750 (59.5)	12,400 (64)	12,050 (67)
40			9,920 (35.5)	9,650 (45.5)	10,200 (54.5)	10,250 (60)	10,350 (63.5)
45			7,420 (23)	7,190 (38)	8,000 (49.5)	8,370 (55.5)	8,750 (60)
50				5,300 (29)	6,100 (44)	6,640 (51)	7,180 (56.5)
55				3,810 (13.5)	4,430 (37.5)	4,940 (46.5)	5,650 (52.5)
60					2,960 (30)	3,560 (41.5)	4,170 (48.5)
65					1,650 (19.5)	2,190 (35.5)	2,740 (44)
70							1,340 (39)

NOTE: ( ) Boom angles are in degrees.

\*63 ft. boom length is with inner-mid extended and outer-mid and fly retracted.

Boom Angle	37	45	55	*63
0°	19,300 (29.8)	11,650 (37.8)	6,310 (47.8)	3,610 (55.8)

A6-829-012231A



37 - 115 ft.  
(11.2 - 35 m)



9,500 lbs.  
(4309 kg)



Stationary  
29.5 x 25 - 28PR Tires



360°



(Feet)	37	45	55	*63	75	85	95
10	33,250 (68.5)	31,400 (73)					
12	29,100 (65)	27,450 (70)	25,850 (74)				
15	23,700 (59.5)	22,350 (65.5)	21,650 (70.5)				
20	16,550 (49)	15,550 (58)	15,200 (65)	14,950 (68.5)	13,150 (72.5)	12,050 (75)	
25	10,900 (36)	10,800 (49.5)	10,600 (58.5)	10,500 (63.5)	9,600 (68)	9,990 (71)	9,110 (73.5)
30		7,560 (39.5)	7,120 (52)	6,780 (58)	7,000 (64)	8,030 (67.5)	9,110 (70.5)
35		5,000 (26)	4,700 (44.5)	4,460 (52)	5,000 (59.5)	6,170 (64)	6,650 (67)
40			2,620 (35.5)	2,310 (45.5)	3,410 (54.5)	4,410 (60)	4,650 (63.5)
45					2,120 (49.5)	2,730 (55.5)	3,010 (60)
50					1,050 (44)	1,130 (51)	1,590 (56.5)

NOTE: ( ) Boom angles are in degrees.

\*63 ft. boom length is with inner-mid extended and outer-mid and fly retracted.

Boom Angle	37	45
0°	8,320 (29.8)	3,840 (37.8)

A6-829-012232A



37 - 115 ft.  
(11.2 - 35 m)



9,500 lbs.  
(4309 kg)



Pick & Carry  
Up to 2.5 MPH  
29.5 x 25 - 28PR Tires



Boom Centered Over Front



(Feet)	37	45	55	*63	75	85	95
10	47,050 (68.5)	32,100 (73)					
12	43,800 (65)	32,100 (70)	28,150 (74)	25,000 (76.5)			
15	39,200 (59.5)	32,100 (65.5)	28,150 (70.5)	25,000 (73.5)	19,650 (76.5)		
20	32,100 (49)	32,100 (58)	28,150 (65)	25,000 (68.5)	19,650 (72.5)	16,500 (75)	11,850 (77)
25	25,650 (36)	25,450 (49.5)	25,200 (58.5)	25,000 (63.5)	19,650 (68)	16,500 (71)	11,850 (73.5)
30		18,650 (39.5)	18,150 (52)	17,800 (58)	18,050 (64)	16,500 (67.5)	11,850 (70.5)
35		13,650 (26)	13,300 (44.5)	13,000 (52)	14,500 (59.5)	15,750 (64)	11,850 (67)
40			9,800 (35.5)	9,550 (45.5)	10,800 (54.5)	11,850 (60)	11,850 (63.5)
45			7,420 (23)	7,190 (38)	8,400 (49.5)	9,410 (55.5)	10,150 (60)
50				5,300 (29)	6,410 (44)	7,340 (51)	8,040 (56.5)
55				3,810 (13.5)	4,840 (37.5)	5,700 (46.5)	6,360 (52.5)
60					3,590 (30)	4,370 (41.5)	5,000 (48.5)
65					2,560 (19.5)	3,280 (35.5)	3,650 (44)
70						2,300 (28.5)	2,400 (39)
75						1,400 (28.5)	1,520 (33.5)

NOTE: ( ) Boom angles are in degrees.

\*63 ft. boom length is with inner-mid extended and outer-mid and fly retracted.

Boom Angle	37	45	55	*63	75	85
0°	19,300 (29.8)	11,200 (37.8)	6,310 (47.8)	3,610 (55.8)	2,070 (67.8)	1,180 (77.8)

A6-829-012233A



37 - 115 ft.  
(11.2 - 35 m)



9,500 lbs.  
(4309 kg)



Stationary  
29.5R - 25 Tires



Defined Arc  
Over Front



(Pounds)

(Feet)	37	45	55	*63	75	85	95
10	50,000 (68.5)	50,000 (73)					
12	50,000 (65)	50,000 (70)					
15	42,800 (59.5)	42,800 (65.5)	42,800 (70.5)				
20	34,100 (49)	34,100 (58)	34,100 (65)	27,250 (68.5)			
25	27,700 (36)	27,300 (49.5)	26,800 (58.5)	26,400 (63.5)	20,050 (68)	18,800 (71)	
30		19,600 (39.5)	19,050 (52)	18,600 (58)	19,850 (64)	18,800 (67.5)	15,500 (70.5)
35		14,400 (26)	14,000 (44.5)	13,650 (52)	14,750 (59.5)	15,650 (64)	13,400 (67)
40			10,450 (35.5)	10,150 (45.5)	11,200 (54.5)	12,050 (60)	11,550 (63.5)
45			7,710 (23)	7,620 (38)	8,580 (49.5)	9,390 (55.5)	9,840 (60)
50				5,650 (29)	6,580 (44)	7,350 (51)	8,120 (56.5)
55				4,100 (13.5)	4,990 (37.5)	5,730 (46.5)	6,470 (52.5)
60					3,780 (30)	4,460 (41.5)	5,140 (48.5)
65					2,700 (19.5)	3,420 (35.5)	4,040 (44)
70						2,520 (28.5)	3,110 (39)
75						1,550 (18.5)	2,250 (33.5)
80							1,300 (27)

NOTE: ( ) Boom angles are in degrees.

\*63 ft. boom length is with inner-mid extended and outer-mid and fly retracted.

Boom Angle	37	45	55	*63	75	85
0°	20,350 (29.8)	12,300 (37.8)	6,710 (47.8)	3,900 (55.8)	2,000 (67.8)	1,090 (77.8)

A6-829-011792C





37 - 115 ft.  
(11.2 - 35 m)



9,500 lbs.  
(4309 kg)



Stationary  
29.5R 25 Tires



360°



(Feet)



	37	45	55	*63	75	85	95
10	50,000 (68.5)	50,000 (73)					
12	46,550 (65)	46,400 (70)					
15	31,800 (59.5)	31,550 (65.5)	31,200 (70.5)				
20	19,550 (49)	19,200 (58)	18,800 (65)	18,450 (68.5)			
25	13,200 (36)	12,800 (49.5)	12,300 (58.5)	11,900 (63.5)	12,950 (68)	13,850 (71)	
30		8,860 (39.5)	8,330 (52)	7,910 (58)	8,880 (64)	9,690 (67.5)	10,500 (70.5)
35		5,990 (26)	5,550 (44.5)	5,190 (52)	6,100 (59.5)	6,860 (64)	7,620 (67)
40			3,540 (35.5)	3,240 (45.5)	4,100 (54.5)	4,350 (60)	4,350 (63.5)
45			1,730 (23)	1,520 (38)	1,520 (49.5)	1,520 (55.5)	1,520 (60)

NOTE: ( ) Boom angles are in degrees.

\*63 ft. boom length is with inner-mid extended and outer-mid and fly retracted.

Boom Angle	37	45
0°	9,470 (29.8)	4,780 (37.8)

A6-829-011793C



37 -115 ft.  
(11.2 - 35 m)



9,500 lbs.  
(4309 kg)



Pick & Carry  
Up to 2.5 MPH  
29.5R - 25 Tires



Boom Centered Over Front



(Pounds)

(Feet)	37	45	55	*63	75	85	95
10	57,700 (68.5)	57,700 (73)					
12	57,700 (65)	57,700 (70)					
15	57,700 (59.5)	57,700 (65.5)	57,700 (70.5)				
20	41,350 (49)	41,000 (58)	40,550 (65)	29,900 (68.5)			
25	27,700 (36)	27,300 (49.5)	26,800 (58.5)	26,400 (63.5)			
30		19,550 (39.5)	19,050 (52)	18,600 (58)	19,850 (64)	20,850 (67.5)	18,800 (70.5)
35		14,400 (26)	14,000 (44.5)	13,650 (52)	14,750 (59.5)	15,650 (64)	16,550 (67)
40			10,450 (35.5)	10,150 (45.5)	11,200 (54.5)	12,050 (60)	12,900 (63.5)
45			7,710 (23)	7,620 (38)	8,580 (49.5)	9,390 (55.5)	10,200 (60)
50				5,650 (29)	6,580 (44)	7,350 (51)	8,120 (56.5)
55				4,100 (13.5)	4,990 (37.5)	5,730 (46.5)	6,470 (52.5)
60					3,780 (30)	4,460 (41.5)	5,140 (48.5)
65					2,700 (19.5)	3,420 (35.5)	4,040 (44)
70						2,520 (28.5)	3,110 (39)
75						1,550 (18.5)	2,320 (33.5)
80							1,300 (27)

NOTE: ( ) Boom angles are in degrees.

\*63 ft. boom length is with inner-mid extended and outer-mid and fly retracted.

Boom Angle	37	45	55	*63	75	85
0°	20,350 (29.8)	12,300 (37.8)	6,710 (47.8)	3,900 (55.8)	2,000 (67.8)	1,090 (77.8)

A6-829-011794C

# ***WEIGHT REDUCTIONS FOR LOAD HANDLING DEVICES***

<b>35 FT. BOOM EXTENSION</b>	
<b>*Stowed -</b>	<b>670 lbs.</b>
<b>*Erected -</b>	<b>5,180 lbs.</b>
<b>35 - 60 FT. TELE. BOOM EXTENSION</b>	
<b>*Stowed -</b>	<b>896 lbs.</b>
<b>*Erected (Retracted) -</b>	<b>6,801 lbs.</b>
<b>*Erected (Extended) -</b>	<b>9,230 lbs.</b>

**\*Reduction of main boom capacities**

<b>AUXILIARY BOOM HEAD</b>	<b>110 lbs.</b>
<b>HOOKBLOCKS and HEADACHE BALLS:</b>	
<b>55 Ton, 4 Sheave w/cheekplates</b>	<b>1,328 lbs.+</b>
<b>55 Ton, 4 Sheave w/o cheekplates</b>	<b>1,040 lbs.+</b>
<b>15 Ton,1 Sheave</b>	<b>420 lbs.+</b>
<b>10 Ton Headache Ball</b>	<b>560 lbs.+</b>

**+Refer to rating plate for actual weight.**

**NOTES:**

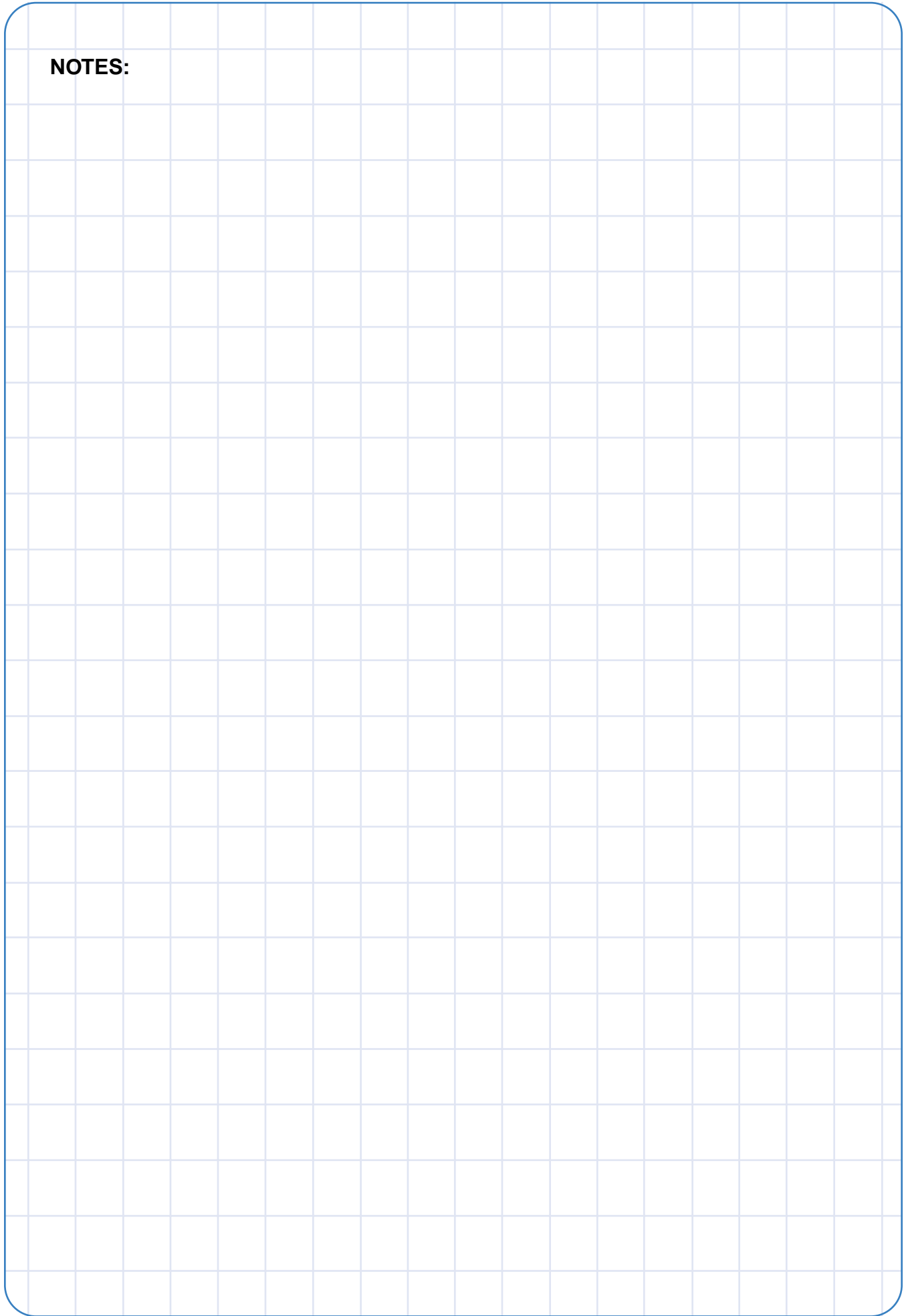

# Rated Lifting Capacities

## IMPORTANT NOTES:

### WARNING: THIS CHART IS ONLY A GUIDE.

The notes below are for illustration only and should not be relied upon to operate the crane. The individual crane's load chart, operating instructions and other instruction plates must be read and understood prior to operating the crane.

1. All rated loads have been tested to and meet minimum requirements of SAE J1063 NOV93 - Cantilevered Boom Crane Structures - Method of Test, and do not exceed 85% of the tipping load on outriggers full extended and 50% extended, and 75% of the tipping load on outriggers 0% extended (fully retracted) and rubber, as determined by SAE J765 OCT90 Crane Stability Test Code.

2. Capacities given do not include the weight of hookblocks, slings, auxiliary lifting equipment and load handling devices. Their weights must be added to the load to be lifted. When more than minimum required reeving is used, the additional rope weight shall be considered part of the load.





































3. Capacities appearing above the bold line are based on structural strength. Tipping should never be used to indicate capacity limitation.

4. All capacities are for crane on firm, level surface. It may be necessary to have structural supports under the outrigger floats or tires to spread the load to a larger bearing surface.

5. When either boom length or radius or both are between values listed, the smallest load shown at either the next larger radius or boom length shall be used.

6. For outrigger operation, ALL outriggers shall be properly extended with tires raised free of ground before raising the boom or lifting loads.

## Symbols Glossary

	Frame		Steering
	Outriggers		Transmission
	Outrigger Controls		Axles
	Engine		Brakes
	Fuel Tank Capacity		Tires
	Electrical System		Suspension
	Drive		Rotation
	Lights		Boom Elevation
	Cab		Swing
	Boom		Counterweight
	Fixed Swingaway		Oil
	Tele-Swingaway		Hydraulic System
	Jib		Hoist
	Boom Nose		Radius
	Boom Extension		Boom Length
	Speed		Hookblock
	Grade		Gear
	Lattice Extension		Luffing Jib

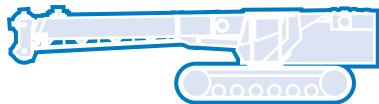
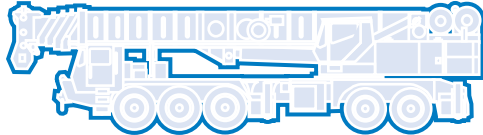
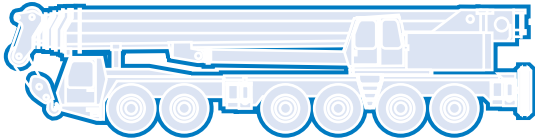
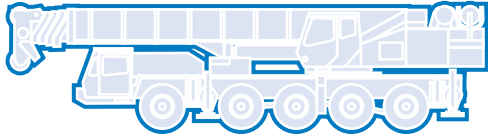

**Grove Worldwide – World Headquarters**

**Grove North America**  
1565 Buchanan Trail East  
P.O. Box 21  
Shady Grove, Pennsylvania 17256, U.S.A.  
Tel: [Int + 1] (717) 597-8121  
Fax: [Int + 1] (717) 597-4062  
Western Hemisphere, Asia/Pacific

**Grove Europe Limited\***  
Sunderland SR4 6TT, England  
Tel: [Int + 44] 191 565-6281  
Fax: [Int + 44] 191 564-0442  
Europe, Africa, Middle East

**Grove Europe Limited\***  
P.O. Box No. 268  
4A Kimber Road  
Abingdon, Oxfordshire, OX141SG  
Tel: [Int + 44] 1235 55-3184  
Fax: [Int + 44] 1235 55-3218

**Deutsche Grove GmbH**  
**Sales and Service**  
Helmholtzstrasse 12, Postfach 5026  
D-40750 Langenfeld, Germany  
Tel: [Int + 49] (2173) 8909-0  
Fax: [Int + 49] (2173) 8909-30

**Wilhelmshaven Works**  
Industriegelände West, Postfach 1853  
D-26358 Wilhelmshaven, Germany  
Tel: [Int + 49] (4421) 294-0  
Fax: [Int + 49] (4421) 294-301

**Grove France S.A.**  
16, chaussée Jules-César, 95520 OSNY  
B.P. 203, 95523 CERGY PONTOISE CEDEX  
France  
Tel: [Int + 33] (1) 30313150  
Int: [Int + 33] (1) 30386085

\*Grove Europe Limited, Registered in England,  
Number 1845128, Registered office, Crown Works,  
Pallion, Sunderland, Tyne & Wear, England SR4 6TT

**Grove Asia/Pacific - Regional Office**

171 Chin Swee Road  
#06-01 San Centre  
Singapore 0316  
Tel: [Int + 65] 536-6112  
Fax: [Int + 65] 536-6119  
Asia/Pacific, Near East

**Grove China - Representative Office**

Beijing Hotel Room 6074  
No. 33 East Chang An Avenue  
Beijing, 100004, China  
Tel: [Int + 86] (10) 513-7766  
Fax: [Int + 86] (10) 513-7307

**Grove Product Support**

Western Hemisphere, Asia/Pacific  
1086 Wayne Avenue  
Chambersburg, Pennsylvania USA  
Tel: [Int + 1] (717) 263-5100  
Fax: [Int + 1] (717) 267-0404

Europe, Africa, Middle East  
Sunderland SR4 6TT, England  
Tel: [Int + 44] 191 565-6281  
Parts Fax: [Int + 44] 191 510-9242  
Service Fax: [Int + 44] 191 510-9560

Constant improvement and engineering progress make it necessary that we reserve the right to make specification, equipment, and price changes without notice. Illustrations shown may include optional equipment and accessories and may not include all standard equipment.

Form No.: RT855B Part No.: 3-669 697-8M Printed in U.S.A.



**CUSTOM SERVICE CRANE, INC.**

www.CustomServiceCrane.com | t: 217-897-1700 | Randy@customservicecrane.com